

For more detailed assembly and installation instructions, scan the QR code below to view our step-by-step installation video.



### Package Contents:

- All-In-One Outdoor Weather Sensor Array
- Display Console with Desk Stand
- Wind Vane
- Wind Cups
- Rain Gauge Funnel
- Rain Gauge Coil
- Mounting Hardware

### Required Tools:

- Precision Screwdriver
- Adjustable Wrench or 10mm Wrench
- (2) AA batteries
- (3) AAA batteries

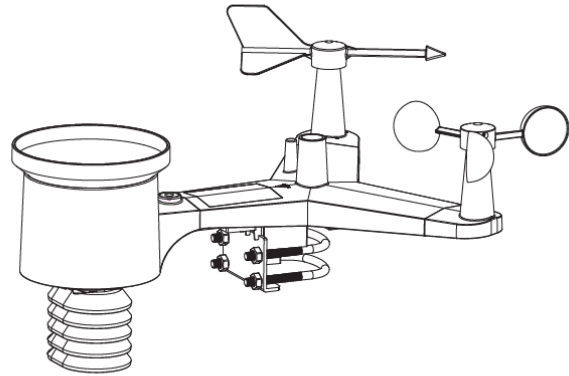

## WS-2902D Quick Setup Guide

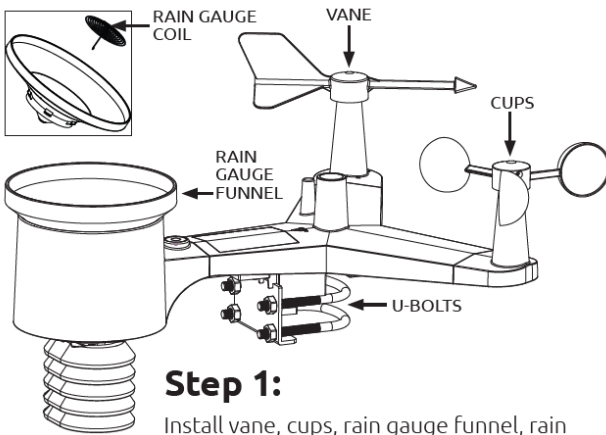

### Step 1:

Install vane, cups, rain gauge funnel, rain gauge coil and U-bolts (not mounting).

**Note:** We recommend assembling the station indoors and moving it outside once the setup process is complete.

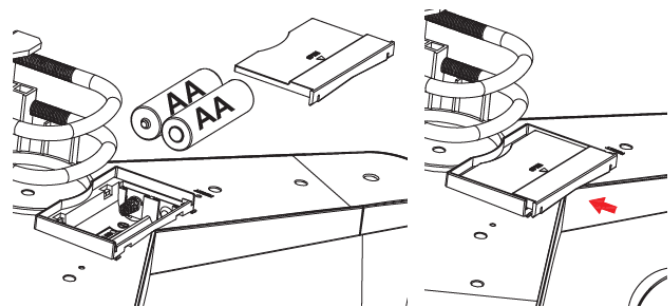

### Step 2:

Insert the 2 - AA batteries into the bottom of the array and close the battery door completely.

### Step 3:

Power up the console using the AC adapter. The console will also hold 3-AAA (not included) for backup battery power.

**Note:** WiFi requires an AC power adapter

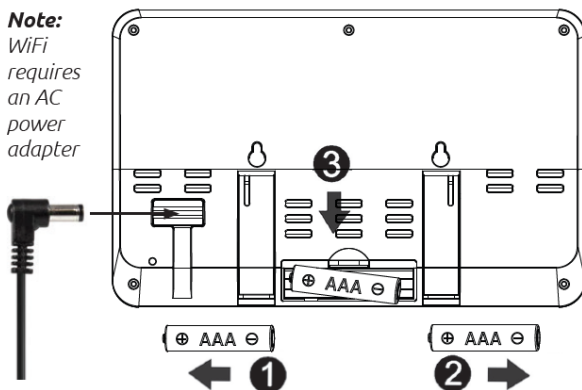

### Step 4:

Follow the cling cover instructions to register and connect your weather station to the Ambient Weather Network.

After you power up your console using the provided AC adapter, go to the WiFi Settings on your computer, tablet, or smartphone and select the wireless network that starts with AMBWeatherPro.

### Step 5:

Go to your browser and enter 192.168.4.1 into the URL bar.

On the setup screen, enter your email address, select your WiFi network, and enter your WiFi password. Once complete, check your email for steps to set up this device on AmbientWeather.net.

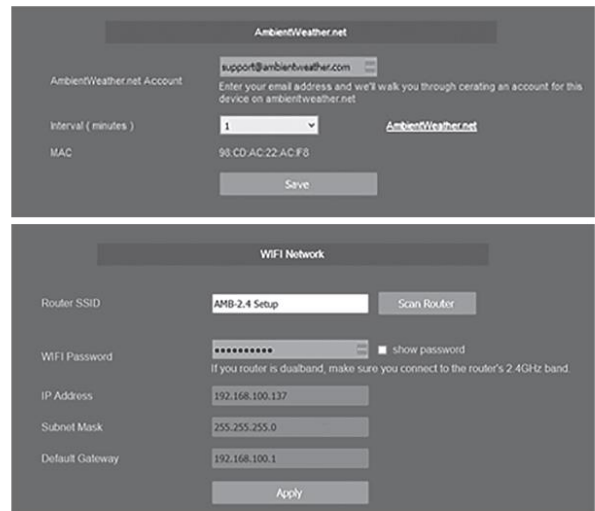

### Step 6:

Check your email to confirm your dashboard setup on AmbientWeather.net. Your email will look something like this, depending on if this is your first account or if you already have an account with us.

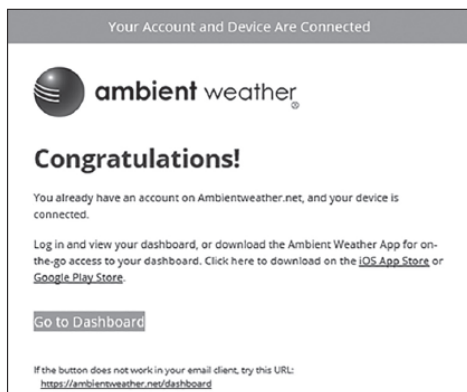

### Step 7:

Install your array on a pole and tighten the U-bolts with a 10mm wrench. Please scan the QR code for mounting best practices.

**Note:** Supports poles 1.25-2" OD.

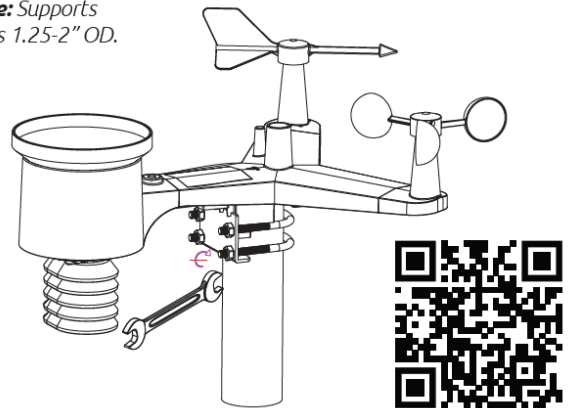

# AWN AMBIENT WEATHER NETWORK™

Enhanced by a powerful network of weather stations, the Ambient Weather Network provides the most accurate hyperlocal conditions for your neighborhood, activity, or business. Connect your compatible Ambient Weather Station to access your data remotely and join one of the fastest-growing weather communities. Personalize your data tiles, set alerts, and share your weather updates with other weather enthusiasts on our platform, which is always ad-free and free of charge!



### Multiple Map Layers

Select the radar, wind, or temperature layers or drill down to view your neighborhood's weather stations.

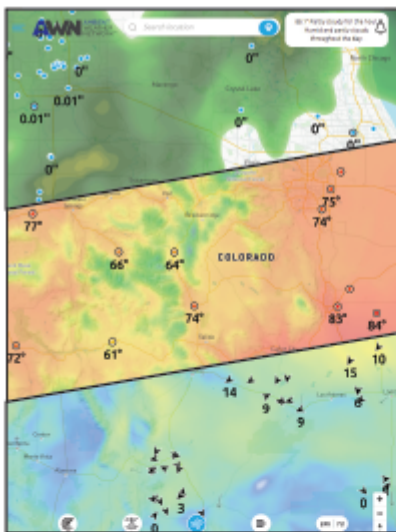

### Customizable Forecast

Add your personal weather station to the map and create your own forecast for the community.



### Local Weather Cameras

Watch timelapse videos of weather conditions from local weather cameras or add your own.

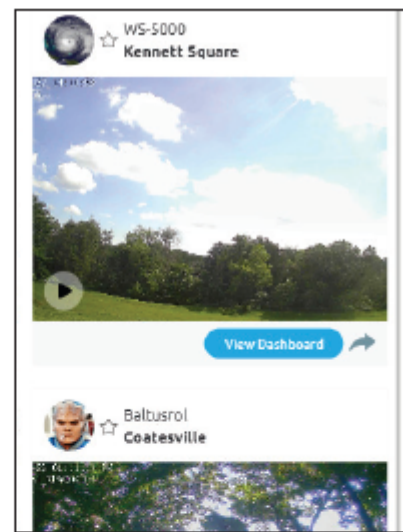

Scan the QR Code below to download the Ambient Weather Network App for free on the iOS App Store or Android Google Play Store.



# Ambient Weather WS-2902D Wi-Fi Solar-Powered Wireless Weather Station User Manual



## Table of Contents

1.	Introduction.....	5
1.1	Product History .....	5
2.	Warnings and Cautions .....	6
3.	Quick Start Guide .....	6
4.	Sensor Array Set Up.....	7
4.1	Parts List.....	7
4.2	Included Tools .....	7
4.3	Recommended Tools .....	7
4.4	Wind Vane Installation .....	8
4.5	Wind Cups Installation .....	8
4.6	Rain Gauge Funnel Installation.....	8
4.7	Funnel Coil Filter Installation .....	9
4.8	Battery Installation .....	9
5.	Display Console.....	10
6.	Vertical Desk Stand.....	11
7.	Console Initialization .....	12
7.1	Button Operation.....	12
8.	Screen Display .....	13
9.	Connecting the Weather Station Console to Wi-Fi .....	14
9.1	Find the WS-2902D from your device (computer, smart phone, or tablet with a browser) .....	14
9.1.1	PC Users.....	14
9.1.2	Mac Users .....	15
9.1.3	Linux Users.....	16
10.	Updating Console Firmware .....	18
11.	Customized Server Option .....	19
12.	Registering with Internet Cloud Services .....	19
12.1	Ambient Weather Network.....	19
12.1.1	Ambient Weather Network Apps .....	20
12.1.2	IFTTT.....	21
12.1.3	Amazon Alexa.....	21
12.1.4	Google Assistant .....	21
12.2	Optional Sensors .....	22
12.3	Indoor/Outdoor Thermo-Hygrometer, 8 Channel (Optional).....	23
12.4	PM2.5 Air Quality Sensor (Optional).....	24
12.5	Best Practices for Wireless Communication .....	24
13.	Display Console Operation .....	25
13.1	Set Mode .....	25
13.1.1	Time Zones .....	27
13.2	Barometric Pressure Display.....	28
13.2.1	Viewing Absolute vs. Relative Pressure .....	28
13.2.2	Rate of Change of Pressure Graph.....	28
13.2.3	Viewing Pressure History .....	28
13.2.4	Relative Pressure Calibration Discussion .....	28
13.3	Rain Display.....	29
13.3.1	Rain Increments of Measure .....	29
13.3.2	Resetting Rain.....	29
13.3.3	Increments of Rain Definitions .....	29
13.4	Wind Display.....	30
13.5	Temperature Display .....	30

13.5.1	Wind Chill, Dew Point, and Heat Index Display .....	30
13.6	Alarms .....	30
13.6.1	Viewing High and Low Alarms .....	30
13.6.2	Setting High and Low Alarms .....	30
13.7	Max/Min Mode .....	34
13.7.1	Viewing Max/Min Values .....	34
13.8	Calibration .....	35
13.8.1	Calibration Settings .....	35
13.8.2	Calibration Ranges .....	36
13.8.3	Calibration Discussion .....	37
14	Mounting Pole Installation .....	39
14.1	Pre-Installation Checkout .....	39
14.2	Site Survey .....	40
14.3	Install U-Bolts .....	41
14.4	Aligning the Wind Direction .....	42
15	Restoring the Console to Factory Default .....	42
16	Resynchronizing Wireless Sensor .....	42
17	Backlight Operation .....	42
17.1	With AC Adapter .....	42
17.2	Without AC Adapter .....	42
18	Tendency Arrows .....	42
19	Wireless Signal Quality Indicator .....	43
20	Weather Forecasting .....	43
20.1	Storm Alert .....	43
20.2	Weather Forecasting Description and Limitations .....	44
21	Live Internet Publishing .....	44
22	Glossary of Terms .....	44
23	Specifications .....	46
23.1	Wireless Specifications .....	46
23.2	Measurement Specifications .....	46
23.3	Power Consumption .....	46
24	Maintenance .....	47
25	Troubleshooting Guide .....	47
26	Accessories .....	48
27	Liability Disclaimer .....	49
28	FCC Statement .....	49
29	Warranty Information .....	49
30	California Prop 65 .....	50

## 1. Introduction

Thank you for your purchase of the Ambient Weather WS-2902D Wi-Fi OSPREY Solar-Powered Wireless Weather Station. The following User Guide provides step-by-step instructions for installation, operation, and troubleshooting.

The product is continuously changing and improving, particularly online services and associated applications. To download the latest manual and for additional help, please visit:

<https://ambientweather.com/faqs/question/tags/tag/WS-2902D/>

### 1.1 Product History

- **WS-2902:** Initial product release. Used Ambient Tool app for WiFi setup.
- **WS-2902A:** Added Wi-Fi broadcast mode. This enables users to connect their console to their dual band router without having to disable the 5.0 GHz band.
- **WS-2902B:** Supports 8-channel thermo-hygrometer sensors and PM2.5 sensors. They cannot be viewed on the display console but are passed through to the Ambient Weather Network.

- **WS-2902C:** Improved console layout.
- **WS-2902D:** Console layout improved. Web GUI Wi-Fi setup interface added. Wi-Fi connectivity enabled; Awnet app no longer needed from the App Store/ Google Play Store.

## 2. Warnings and Cautions

**⚠ Warning:** Any metal object may attract a lightning strike, including your weather station mounting pole. Never install the weather station in a storm.

**⚠ Warning:** If you are mounting the weather station to a house or structure, consult a licensed electrician for proper grounding. A direct lightning strike to a metal pole can damage or destroy your home.

**⚠ Warning:** Installing your weather station in a high location may result in injury or death. Perform as much of the initial check out and operation on the ground and inside a building or home.

**⚠ Warning:** Only install the weather station on a clear, dry day.

## 3. Quick Start Guide

The following Quick Start Guide provides the necessary steps to install and operate the weather station.

Step	Description	Section
1	Assemble and power up the outdoor Sensor Array	4.1-4.8
2	Power up the display console and synchronize with the outdoor Sensor Array	7
3	Configure Wi-Fi via web GUI	9
4	Register and upload to the Ambient Weather Network	12.1
5	Calibrate the relative pressure to sea-level conditions (local airport) on console	13.8.1
6	Mount the Sensor Array	14

## 4. Sensor Array Set Up

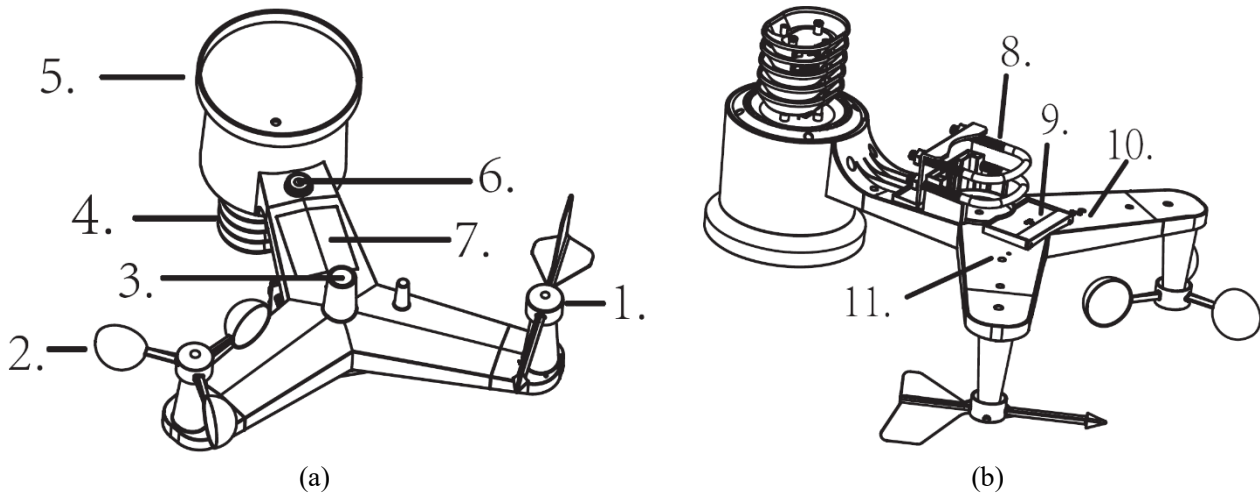

Figure 1

No	Description	No	Description
1	Wind Vane	7	Solar Panel
2	Wind Speed Sensor	8	U-Bolt
3	UV sensor/ Light Sensor	9	Battery Compartment
4	Thermometer-Hygrometer Sensor	10	Reset Button
5	Rain Collector	11	LED Transmitter Indicator
6	Bubble Level		

### 4.1 Parts List

QTY	Item
1	Display Console Frame Dimensions (LxWxH): 7.50 x 4.50 x 0.75" LCD Dimensions (LxW): 3.00 x 6.75"
1	Vertical Desk Stand
1	Sensor Array
1	Wind Vane
1	Funnel Coil Filter
1	5V DC Adaptor
2	Pole Mounting U-Bolts
2	Pole Mounting U-Bolt Nuts
1	User Manual

### 4.2 Included tools

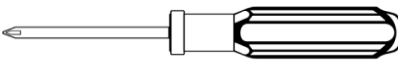
Quantity	Picture	Item
1		Precision Screwdriver #1

### 4.3 Recommended Tools

- Compass or GPS (for wind direction calibration).

## 4.4 Wind Vane Installation

Reference Figure . (a) Locate and align the flat key on the Wind Vane Shaft to the flat key on the Wind Vane and push the vane on to the shaft. (b) Tighten the set screw with a Precision Screwdriver and make sure the Wind Vane spins freely.

 **Note:** You may need to back out the set screw first before sliding the vane onto the shaft.

 **Note:** The Wind Vane shaft does not spin as freely as the Wind Cups. This is by design; the dampening prevents the Wine Vane from spinning with the slightest breeze, which will result in variable wind all the time. The added resistance allows the Wind Vane to change direction with 2 – 3 mph, providing much better wind direction tracking.

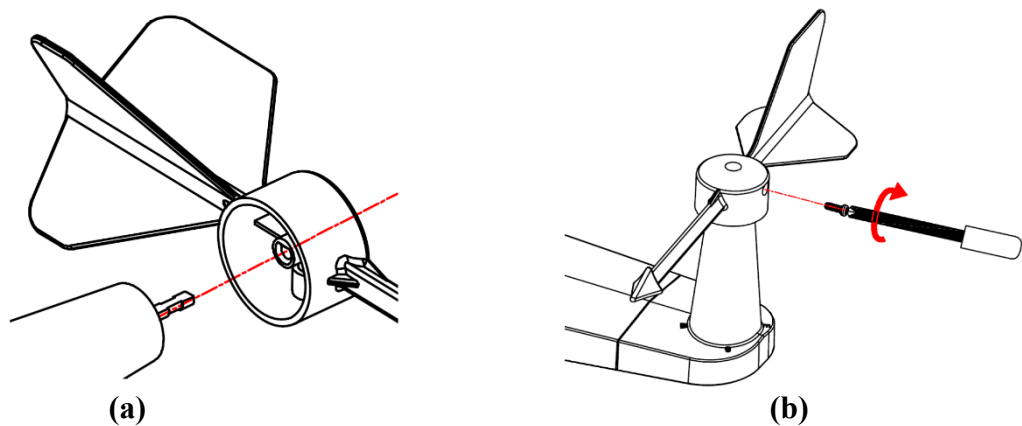



Figure 2

## 4.5 Wind Cup Installation

Reference Figure . (a) Push the Wind Cups onto the shaft. (b) Tighten the set screw with a Precision Screwdriver and make sure the Wind Cups spin freely.

 **Note:** You may need to back out the set screw first before sliding the cups onto the shaft.

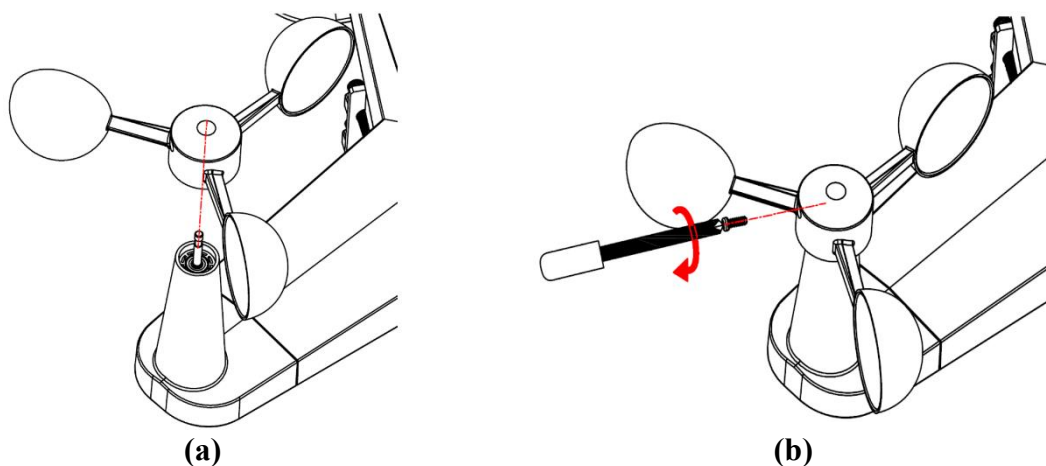
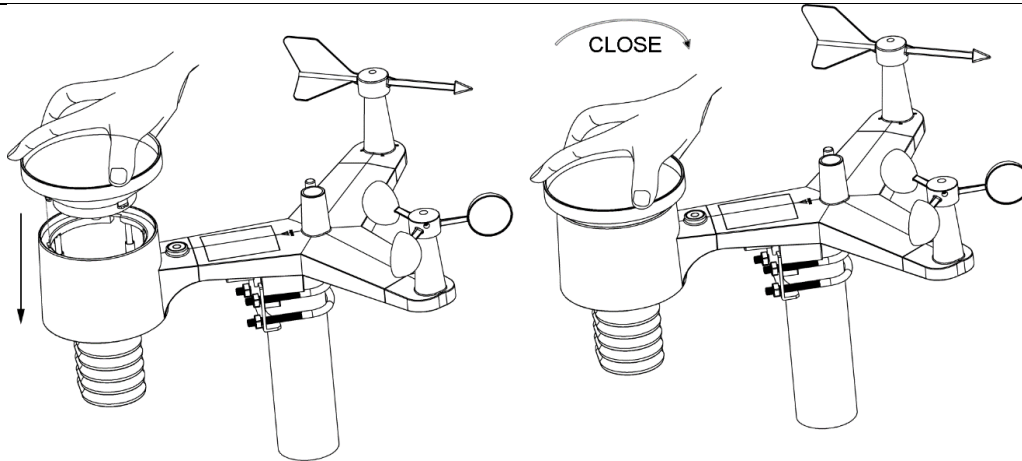

Figure 3

## 4.6 Rain Gauge Funnel Installation

Reference Figure . Install the Rain Gauge Funnel. Rotate clockwise to attach the funnel to the Sensor Array.





**Figure 4**

### 4.7 Funnel Coil Filter Installation

To install the Funnel Coil Filter, press the coil until the hook is inside the hole at the bottom of the funnel and locked in place. The spring tension will keep the filter sitting tightly on the funnel.



**Figure 5**

### 4.8 Battery Installation

Reference Figure . Insert (2) AA non-rechargeable batteries (not included) into the battery compartment. The LED indicator on the back of the transmitter will turn on for four seconds and then flash once every 16 seconds (the sensor transmission update period).

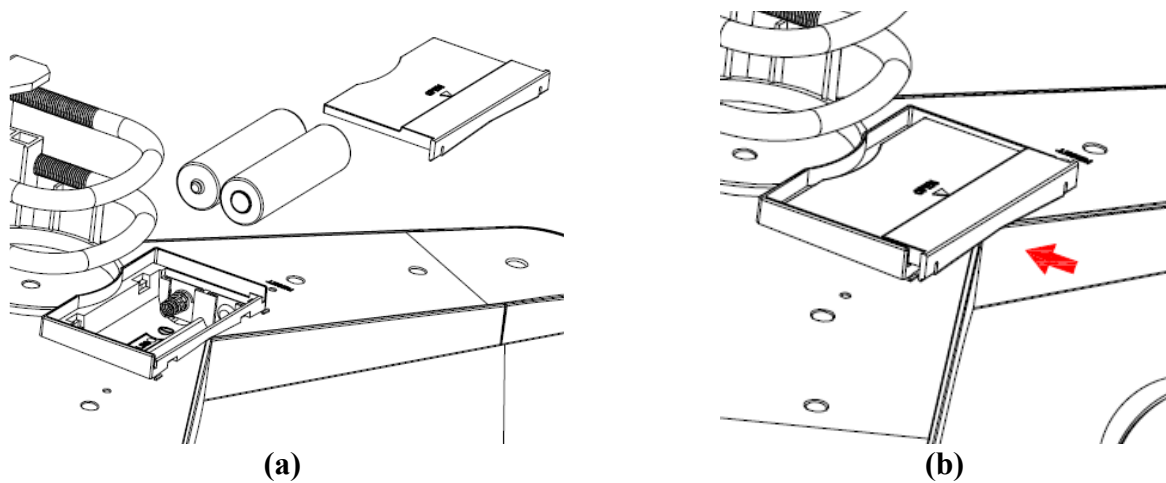

**Figure 6**

 **Note:** If the LED does not light up or stays on permanently, make sure the battery polarity is correct and that the

batteries are fresh. Do not install the batteries backwards. You can cause permanent damage to the Thermo-Hygrometer.

 **Note:** We recommend lithium batteries for cold weather climates, but alkaline batteries are sufficient for most climates. We do not recommend rechargeable batteries. They have lower voltages, do not operate well at wide temperature ranges, and do not last as long, resulting in poorer reception.

## 5. Display Console

The front and back of the Display Console is shown in Figure 7 and Figure 8.

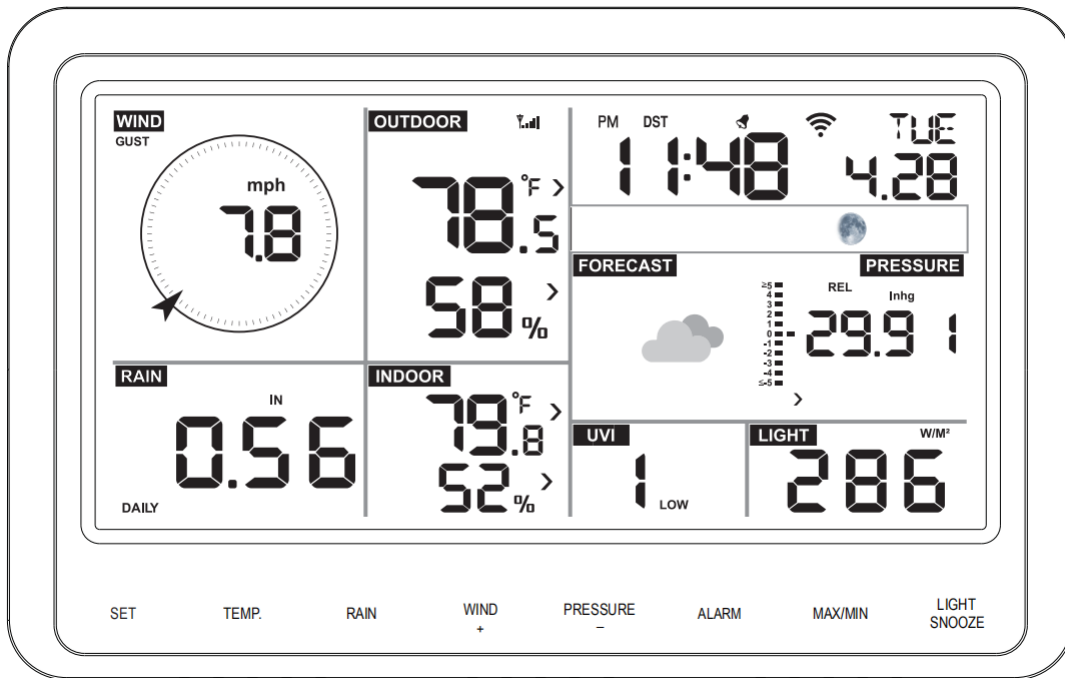

Figure 7

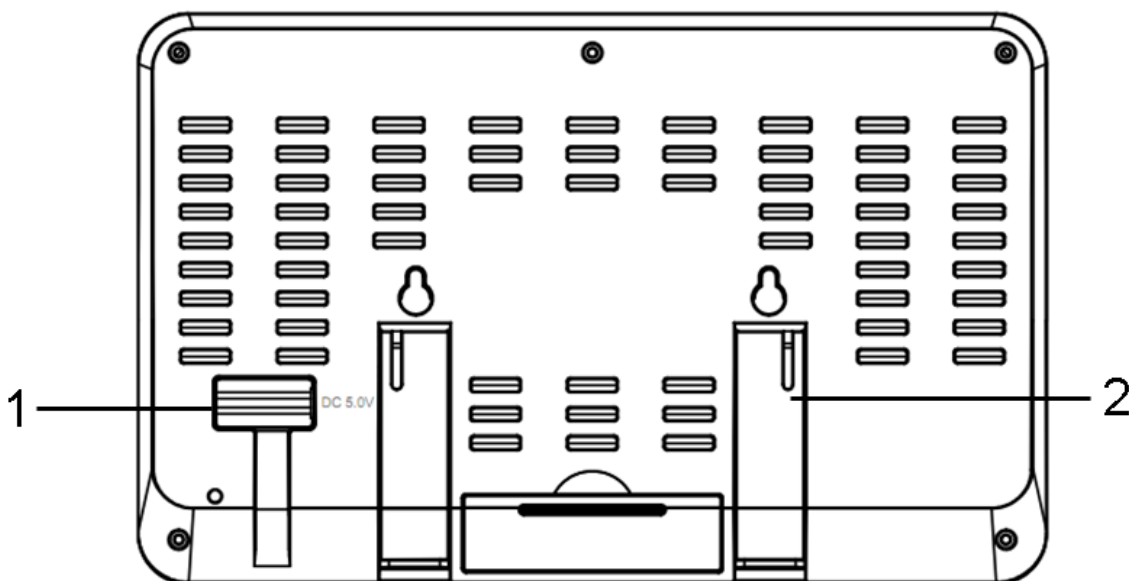

Figure 8

Reference Figure .

- (1) Connect the Display Console power jack, using the included AC Power Adapter.
- (2) Unfold the desk stand and place 5 to 10 feet away from the Sensor Array. Remove the battery door on the back

of the console and insert (3) AAA batteries, per Figure .

- (3) Wait several minutes for the remote sensors to synchronize with the Display Console.

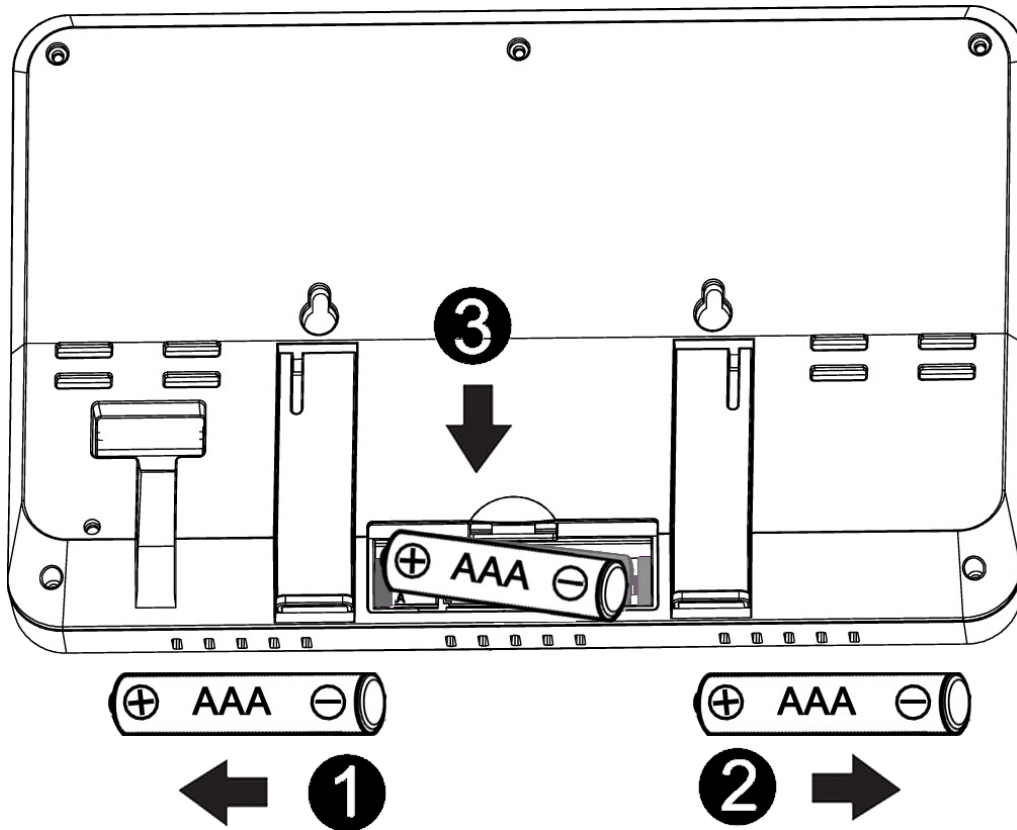

Figure 9

## 6. Vertical Desk Stand

The console is best viewed above from a 20-degree to 30-degree angle. In addition to the fold-out desk stand on the back of the Display Console, the console also includes a vertical desk stand to improve the viewing ability on a desk, as shown in Figure .

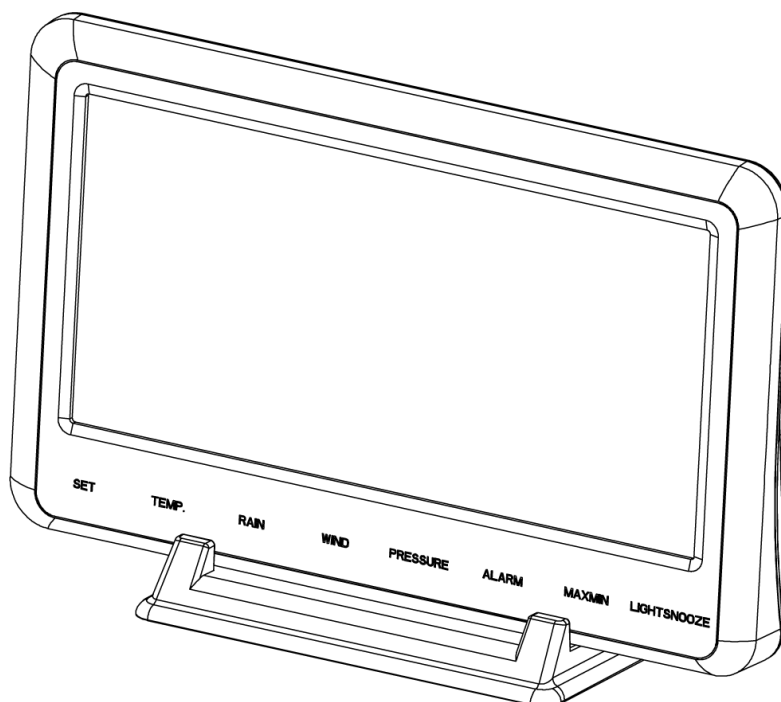

Figure 10

## 7. Console Initialization

After the console is connected to AC power, the console will display the software version number.



Figure 11

The console will display all of the LCD segments for three seconds after power-up, as shown in Figure . The indoor conditions will immediately update, and the outdoor Sensor Array will register within a few minutes.

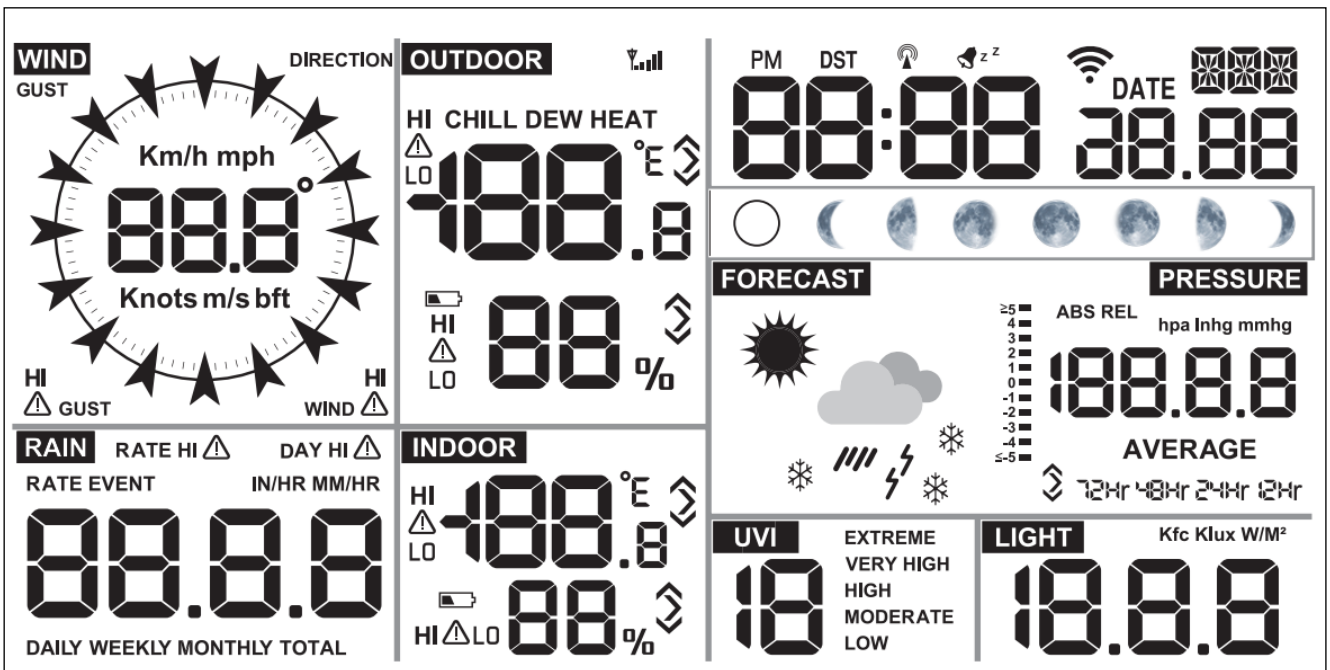

Figure 12

### 7.1 Button Operation

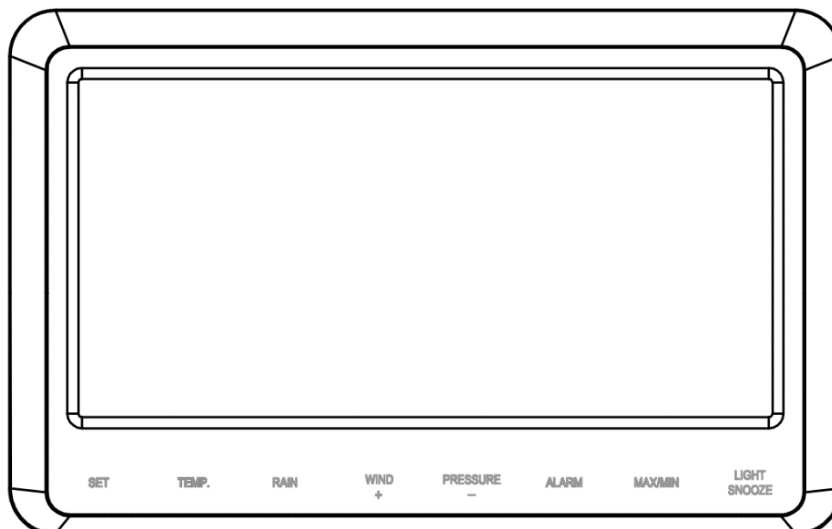

Figure 13

The console has the following 8 buttons at the bottom for easy operation:

Key	Description
<b>SET</b>	Press and hold to enter the SET mode.
<b>TEMP</b>	<ul style="list-style-type: none"> <li>Press to switch between Outdoor Temperature, Wind Chill, Heat Index, and Dew Point.</li> <li>To bypass RF reception, press and hold while powering up the console (connecting the AC adapter with batteries removed).</li> </ul>
<b>RAIN</b>	Press to switch between Rain Rate (inches/hour), Rain Event, Rain Day, Rain Week, Rain Month, and Rain Total.
<b>WIND +</b>	<ul style="list-style-type: none"> <li>Press to switch between average wind speed, wind gust, and wind direction.</li> <li>While in SET mode, press to increase the value. Press and hold for two seconds to increase the value rapidly.</li> </ul>
<b>PRESSURE -</b>	<ul style="list-style-type: none"> <li>Press to switch between Relative Pressure (current), and 12hr, 24hr, 48hr, and 72hr average Relative Pressure.</li> <li>While in SET mode, press to decrease the value. Press and hold for two seconds to decrease the value rapidly.</li> </ul>
<b>ALARM</b>	Press to switch between high and low alarms
<b>MAX/MIN</b>	Press to switch between minimum and maximum values.
<b>LIGHT/SNOOZE</b>	<ul style="list-style-type: none"> <li>Press to adjust the LCD backlight brightness (high, medium, and off).</li> <li>Press to exit the SET mode at any time.</li> </ul>

## 8. Screen Display

The Display Console home screen layout is shown in Figure 1.

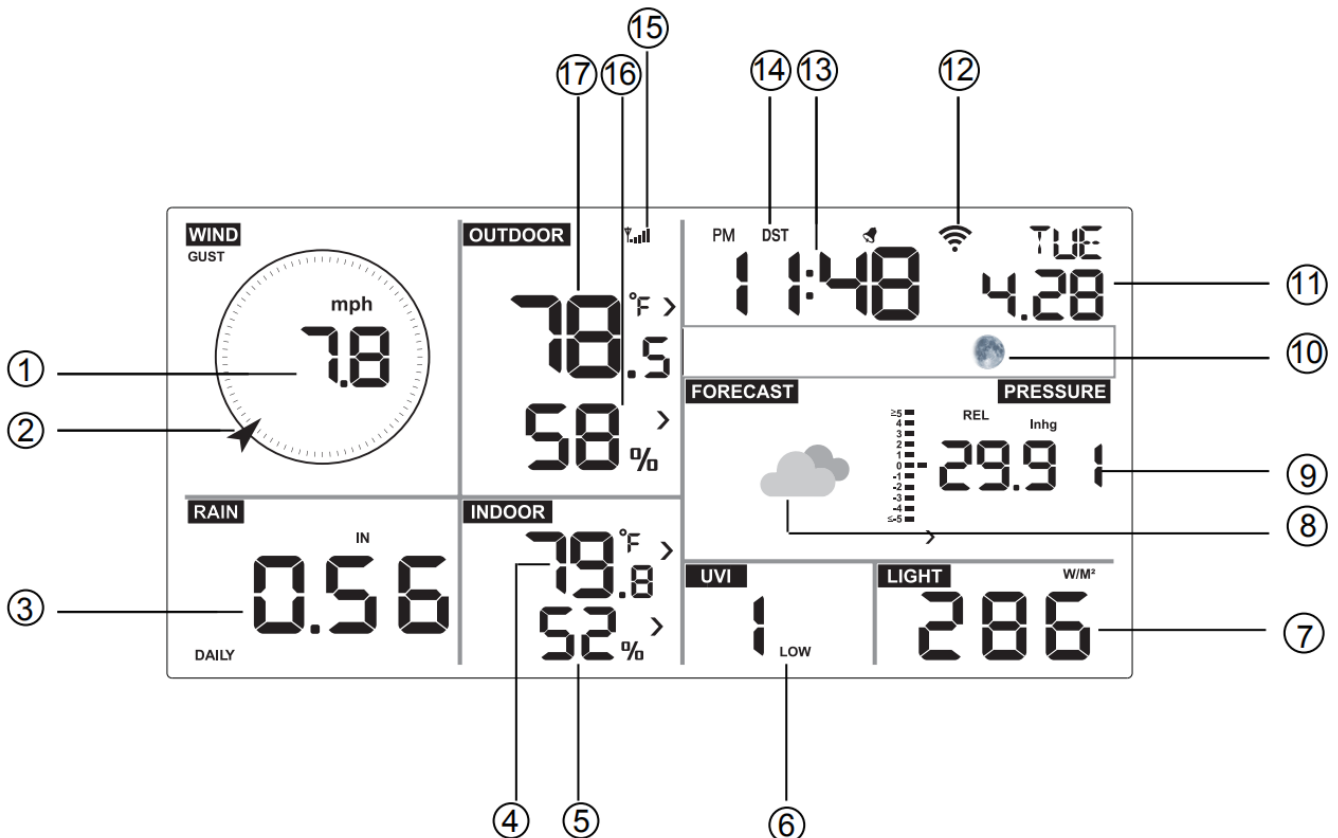



Figure 1

No	Description	No	Description
1	Wind Speed	10	Moon Phase
2	Wind Direction	11	Date
3	Rainfall	12	WIFI Icon
4	Indoor Temperature	13	Time
5	Indoor Humidity	14	Daylight Savings Time (DST)
6	UV index	15	RF Icon
7	Solar Radiation	16	Outdoor Humidity
8	Weather Forecast	17	Outdoor Temperature
9	Barometric Pressure		

## 9. Connecting the Weather Station Console to Wi-Fi

 **Note:** The console broadcasts a 2.4 GHz signal. If you own a dual-band router (2.4 GHz and 5.0 GHz), make sure your router's 2.4 GHz band is on. You are not required to turn off the 5.0 GHz band.

### 9.1 Find the WS-2902D from your device (computer, smart phone, or tablet with a browser)

#### 9.1.1 PC Users

To find the WS-2902D, connect to power and look for the following WiFi network:

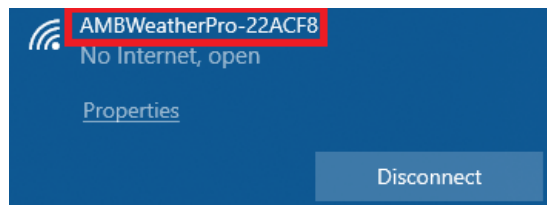

Connect to the network and then open a browser. **Note: You may be told that the network has no internet.**

Navigate to the following IP address: **192.168.4.1**. You will be presented with the following screen:

AmbientWeather.net

AmbientWeather.net Account

Enter your email address and we'll walk you through creating an account for this device on ambientweather.net

Interval ( minutes )  [AmbientWeather.net](#)

MAC

---

WiFi Network

Router SSID

WiFi Password   show password  
If you router is dualband, make sure you connect to the router's 2.4GHz band.

IP Address

Subnet Mask

Default Gateway

You will want to navigate to the Wi-Fi Network area to connect to Wi-Fi. Click [SCAN ROUTER] to find the network or enter the appropriate network name and the password.

WiFi Network

Router SSID

WiFi Password   show password  
If you router is dualband, make sure you connect to the router's 2.4GHz band.

IP Address

Subnet Mask

Default Gateway

Click [APPLY] to connect the console to Wi-Fi. You will receive a message confirming the successful connection.

### 9.1.2 Mac Users

To find the WS-2902D, connect to power and look for the following WiFi network:



Connect to the network and then open a browser. **Note: You may be told that the network has no internet.**

Navigate to the following IP address: 192.168.4.1. You will be presented with the following screen:

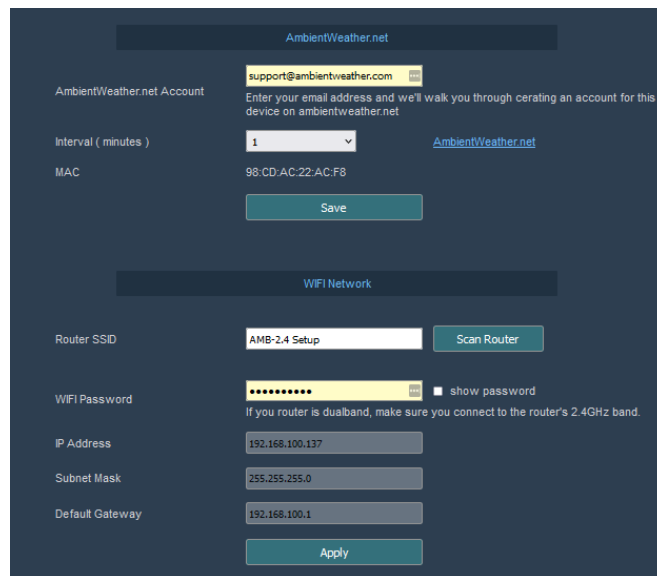

You will want to navigate to the Wi-Fi Network area to connect to Wi-Fi. Click [SCAN ROUTER] to find the network, or you may manually enter your preferred network name and password.

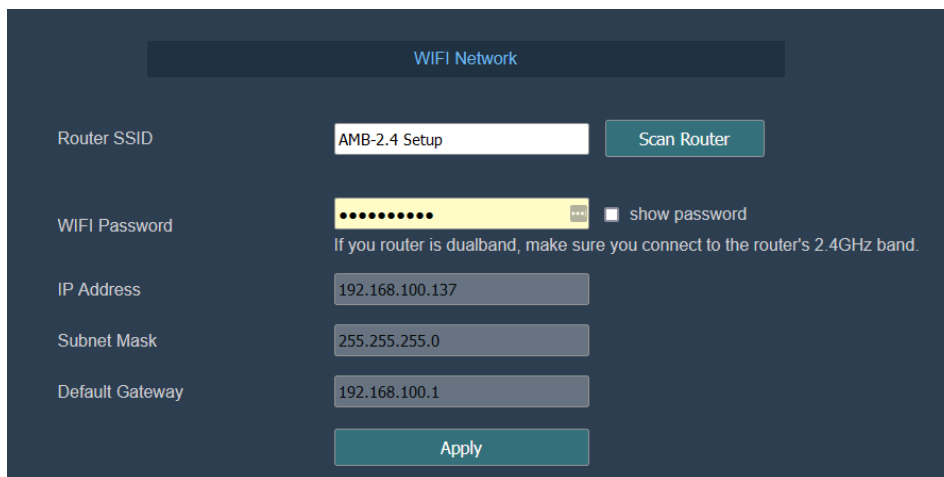

Click [APPLY] to connect the console to Wi-Fi. You will receive a message confirming the successful connection.

### 9.1.3 Linux Users

To find the WS-2902D, connect to power and look for the following WiFi network:



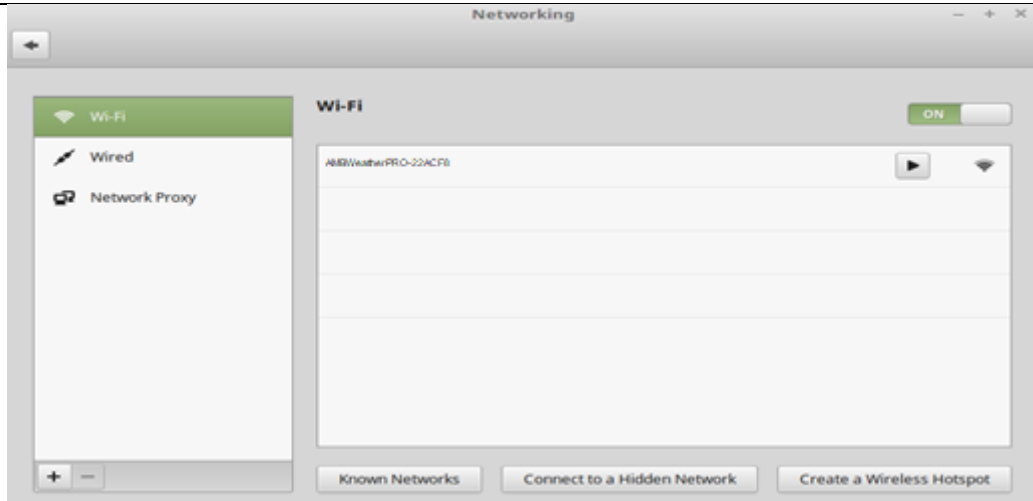

Connect to the network and then open a browser.

**Note: You may be told network has no internet.**

Navigate to the following IP address: 192.168.4.1. You will be presented with the following screen:

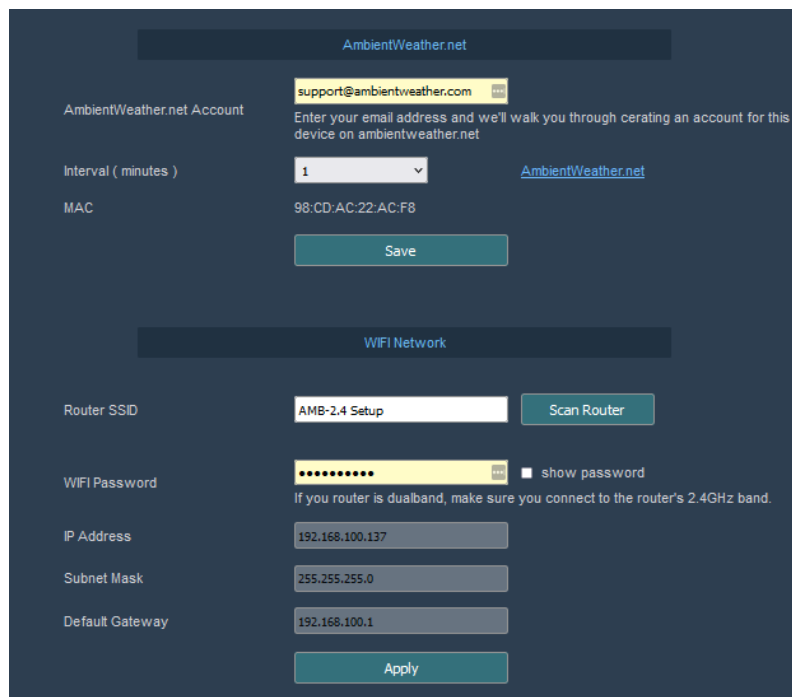

You will want to navigate to the Wi-Fi Network menu to connect to Wi-Fi. Click [SCAN ROUTER] to find the network, or you may manually enter your preferred network name and password.

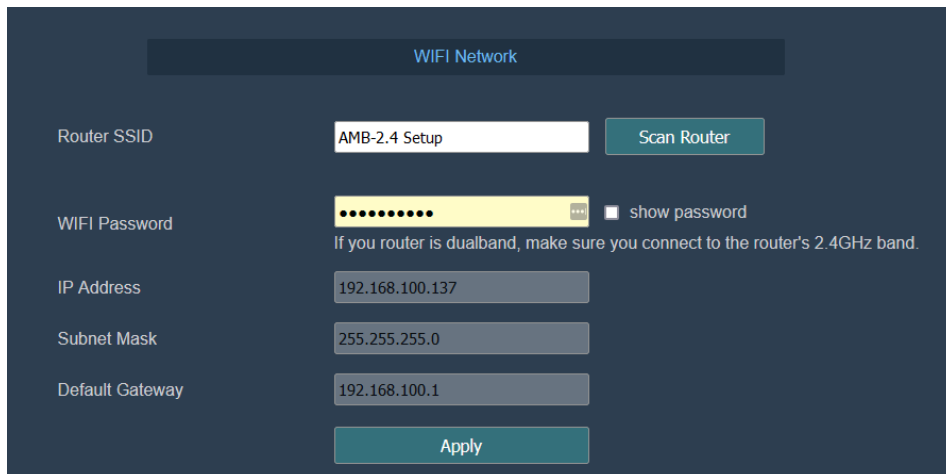

WIFI Network

Router SSID:

WiFi Password:   show password  
If you router is dualband, make sure you connect to the router's 2.4GHz band.

IP Address:

Subnet Mask:

Default Gateway:

Click [APPLY] to connect the console to Wi-Fi. You will receive a message confirming the successful connection.

## 10. Updating Console Firmware

The console firmware is updated using the web GUI, as well. Please proceed to access the console web GUI, using the steps above.

Now navigate to the Firmware area of the screen, as shown in the graphic below. This will display the current version information.

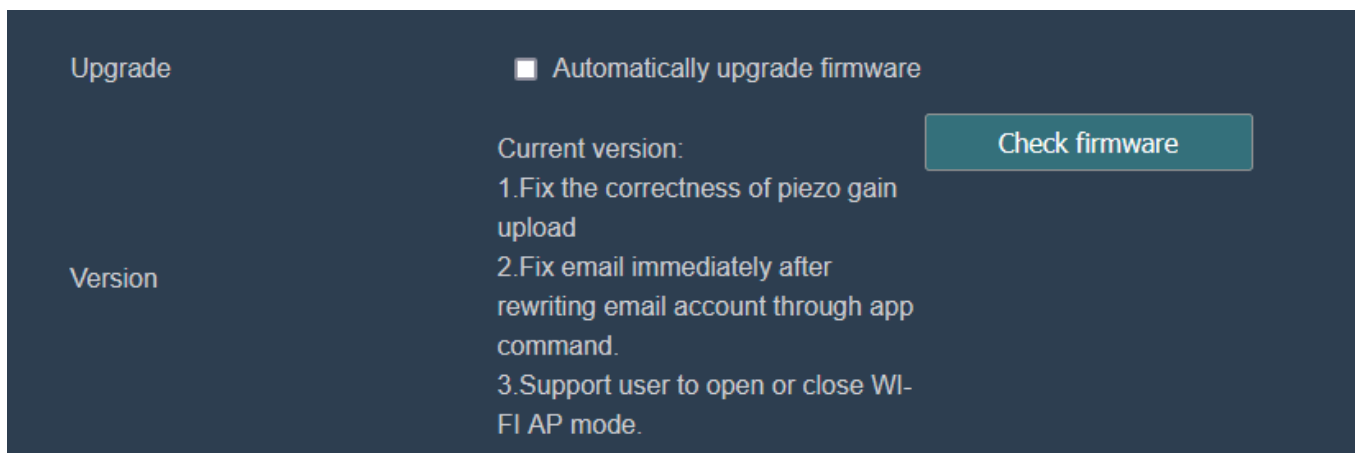

Upgrade  Automatically upgrade firmware

Version

- 1. Fix the correctness of piezo gain upload
- 2. Fix email immediately after rewriting email account through app command.
- 3. Support user to open or close WI-FI AP mode.

You can also enable the console Firmware to be updated automatically, or can check for new Firmware manually by clicking [CHECK FIRMWARE].

This area also allows you to disable the access point the device puts out, 5 minutes after connecting to Wi-Fi.

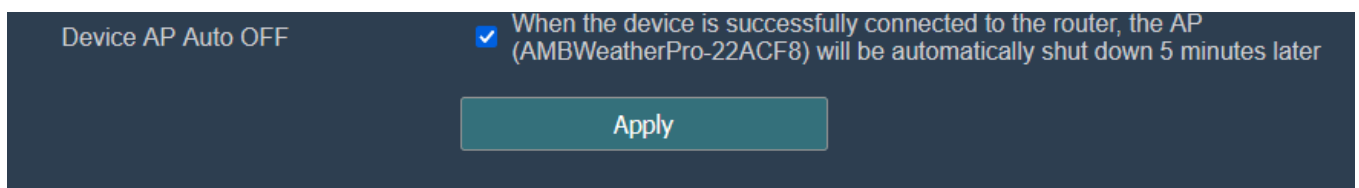

Device AP Auto OFF  When the device is successfully connected to the router, the AP (AMBWeatherPro-22ACF8) will be automatically shut down 5 minutes later

## 11. Customized Server Option

This area of the software allows you enter in customized server option to send data to a private server of your choice. Once the correct information is entered, you will click [SAVE].

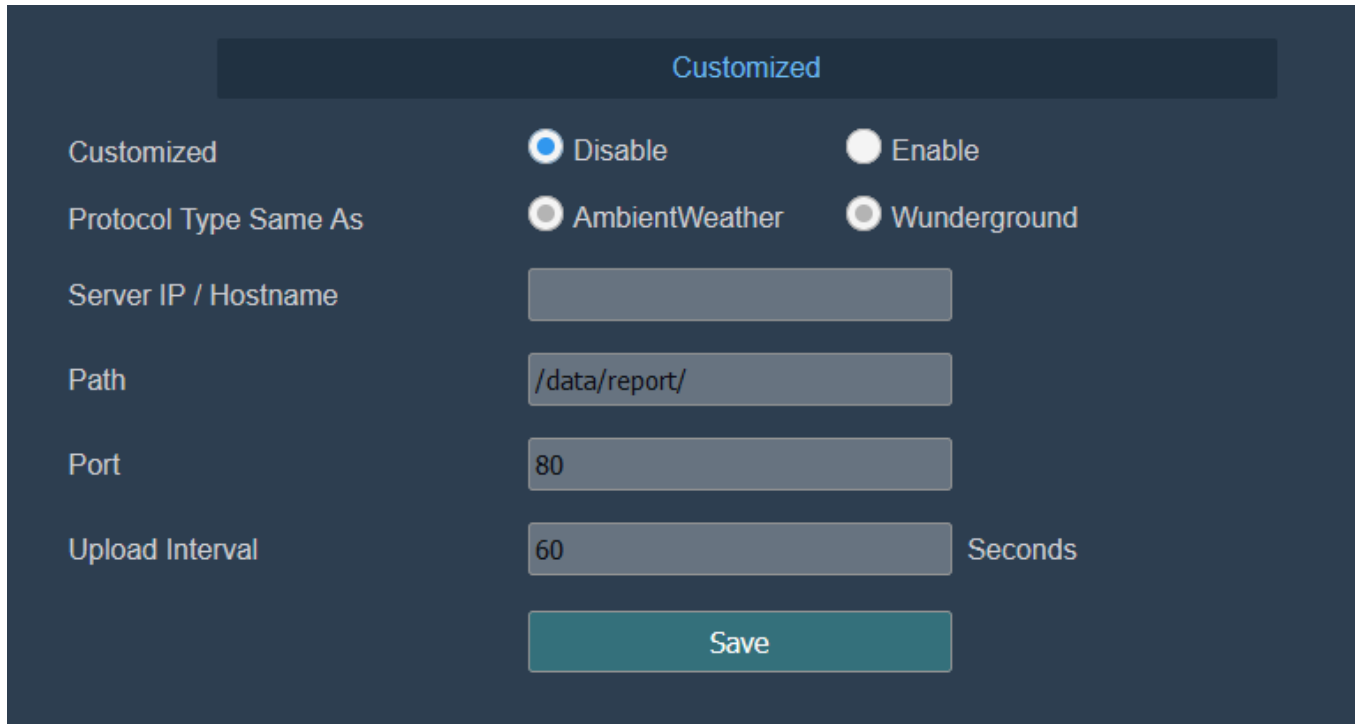

The screenshot shows a configuration page titled "Customized" with a dark blue background. It contains several input fields and radio buttons. The "Customized" section has two radio buttons: "Disable" (selected) and "Enable". The "Protocol Type Same As" section has two radio buttons: "AmbientWeather" (selected) and "Wunderground". Below these are input fields for "Server IP / Hostname", "Path" (containing "/data/report/"), "Port" (containing "80"), and "Upload Interval" (containing "60"). The "Upload Interval" field is followed by the text "Seconds". At the bottom of the form is a teal "Save" button.

## 12 Registering with Internet Cloud Services

### 12.1 Ambient Weather Network

A new feature of the WS-2902D is the ability to register with the Ambient Weather Network through the Web GUI.

Access the Web GUI using the steps above and navigate to the AmbientWeather.net area.

Here you will enter the email address you would like to use for the account and the data frequency interval. To save your changes, click [SAVE].

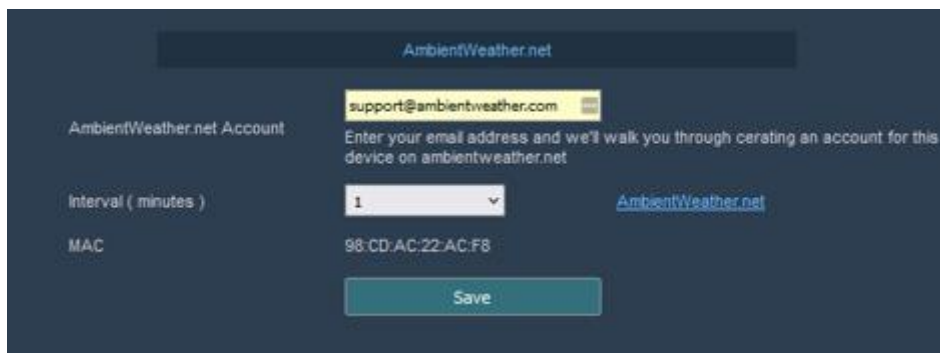

The screenshot shows a registration page titled "AmbientWeather.net" with a dark blue background. It contains an email input field with "support@ambientweather.com" entered. Below the email field is a text prompt: "Enter your email address and we'll walk you through creating an account for this device on ambientweather.net". There is a link to "AmbientWeather.net". Below the email field is a dropdown menu for "Interval ( minutes )" with "1" selected. At the bottom, there is a "MAC" field with the value "98:CD:AC:22:AC:F8" and a teal "Save" button.

Once you have accomplished this step, you will receive a notification of success.

You will then receive an email letting you know about the addition of the device.

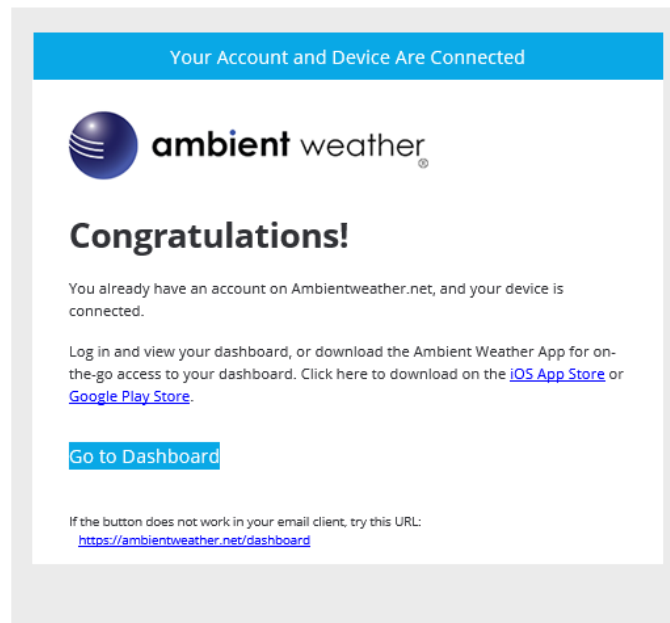

Once registered, select the dashboard to view your data, as shown in Figure .

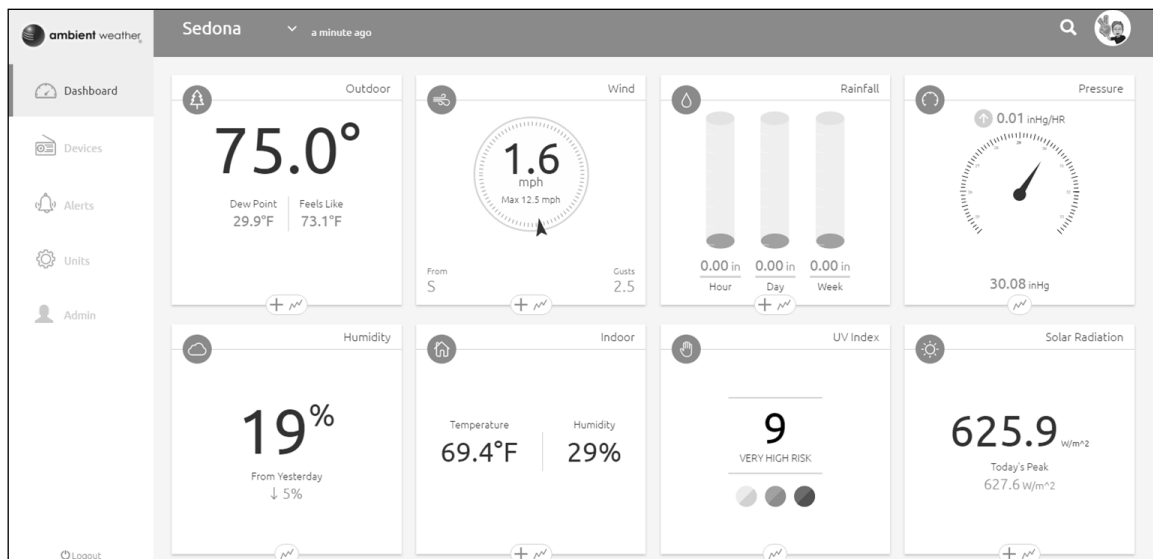

**Figure 15**

### 12.1.1 Ambient Weather Network Apps

Android and iOS Ambient Weather Network apps are available in addition to AmbientWeather.net. Search “Ambient Weather Network” in the Google Play or iOS app store, or visit:

- Ambient Weather Network for Android:  
<https://play.google.com/store/apps/details?id=net.ambientweather.dashboard>
- Ambient Weather Network for iOS:  
<https://apps.apple.com/us/app/ambient-weather-dashboard/id1426025887>



Download the Ambient Weather  
Network App for free

-QR Code-

### 12.1.2 IFTTT

The Ambient Weather Network service connects to IFTTT, the platform that allows devices and services to work together seamlessly.

Here are a few things you can do with IFTTT:

- Turn off your Rachio sprinklers when it rains, when there is too much wind, or when it is below freezing.
- Close your Hunter blinds when the sun is too intense.
- Close your garage door when it is too windy.
- Blink your hue lights when it starts raining.
- Connect to other web services, such as Gmail, Facebook, Instagram, or Pinterest.

For more information on IFTTT and how it can work for you, visit:

[https://ifttt.com/ambient\\_weather](https://ifttt.com/ambient_weather)

### 12.1.3 Amazon Alexa

The Ambient Weather skill allows you to get real-time and past weather information, generated by the devices they have set up at AmbientWeather.net.

Enable the skill and get started: Say, "Alexa, ask Ambient Weather for a weather report." This will provide you with your outdoor weather report, but you can ask for your indoor weather report as well by saying, "Alexa, ask Ambient Weather about the indoor conditions."

You can also ask for a report about a specific day, month, or year. Just say, "Alexa, ask Ambient Weather about the weather yesterday" or "Alexa, ask Ambient Weather about the weather in May."

For more information on Amazon Alexa or to enable this free skill, visit:

<https://www.amazon.com/dp/B074PGCM1D/>

### 12.1.4 Google Assistant

The Ambient Weather Google Assistant app provides Ambient Weather personal weather station owners with the ability to get real-time and past weather information, generated by the devices they have set up at AmbientWeather.net.

Link your account to get started: Say, "Hey Google, Ambient Weather... weather report." This will provide you with your outdoor weather report. You can ask for your indoor weather report as well by saying, "indoor conditions."

You can also link the Ambient Weather app by downloading the Google Assistant.











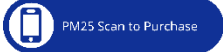

Here are some sample commands:

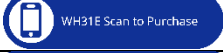

- Weather Report
- Outdoor Conditions
- Indoor Conditions
- Yesterday's Weather
- Conditions for October 15, 2019 [or another specified date]
- Conditions for September 2019 [or another specified month]
- Conditions for 2020 [or another specified year]

For more information and to enable this app, visit:

<https://assistant.google.com/services/a/id/668e6f3369f27209/>

## 12.2 Optional Sensors

Item Number	Number of Channels	Description	Image	Scan QR Code to Purchase
PM25	1	PM2.5 Wireless Outdoor Particulate Monitor		 
PM25IN	1	PM2.5 Wireless Indoor Particulate Monitor		 
WH31E	8*	Thermo-Hygrometer Sensor		 
WH31P	8*	Probed Thermometer		 

WH31PF	8*	Floating Pool Thermometer		  WH31PF Scan to Purchase
--------	----	---------------------------	---	--

(\* ) The WH31E, WH31PF and WH31P share the same 8 channels.

 **Note:** Optional sensor data is not displayed on the console; the data only passes through to the Ambient Weather Network dashboard and cannot be calibrated.

### 12.3 Indoor/Outdoor Thermo-Hygrometer, 8 Channel (Optional)

The WS-2902D supports up to 8 additional Thermo-Hygrometer sensors, and the console receives and sends this data directly to the Ambient Weather Network. (WH31E, WH31PF and WH31P share the same 8 channels). The data is not displayed on the console (pass-through only) and cannot be calibrated.

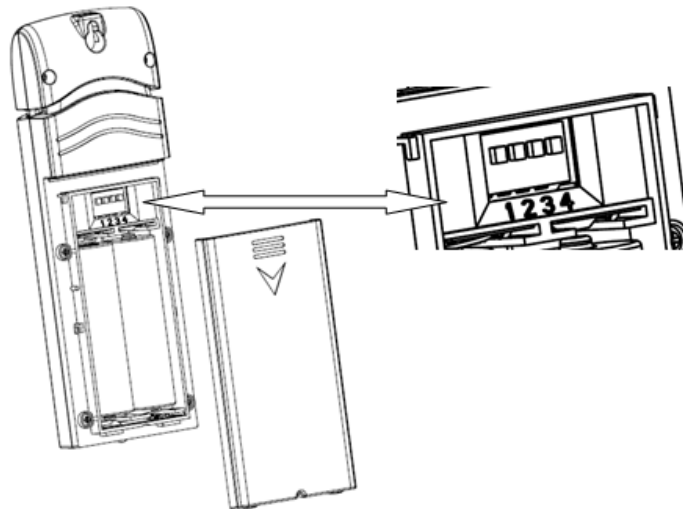

 **Note:** Do not use rechargeable batteries. We recommend fresh alkaline batteries for outdoor temperature ranges between -4 °F and 140 °F and fresh lithium batteries for outdoor temperature ranges between -40 °F and 140 °F.

1. Remove the battery door on the back of the transmitter(s) by sliding down the battery door, as shown in Figure 2.



**Figure 2**

2. **BEFORE** inserting the batteries, locate the dip switches on the inside cover of the lid of the transmitter.
3. **Channel Number:** The WS-2902D supports up to eight transmitters. To set each channel number (the default is Channel 1), change Dip Switches 1, 2 and 3, as referenced in Figure 3.
4. **Temperature Units of Measurement:** To change the units of measurement on the transmitter display (°F vs. °C), change Dip Switch 4, as referenced in Figure 3.

 Switch in the down position.
  Switch in the up position.

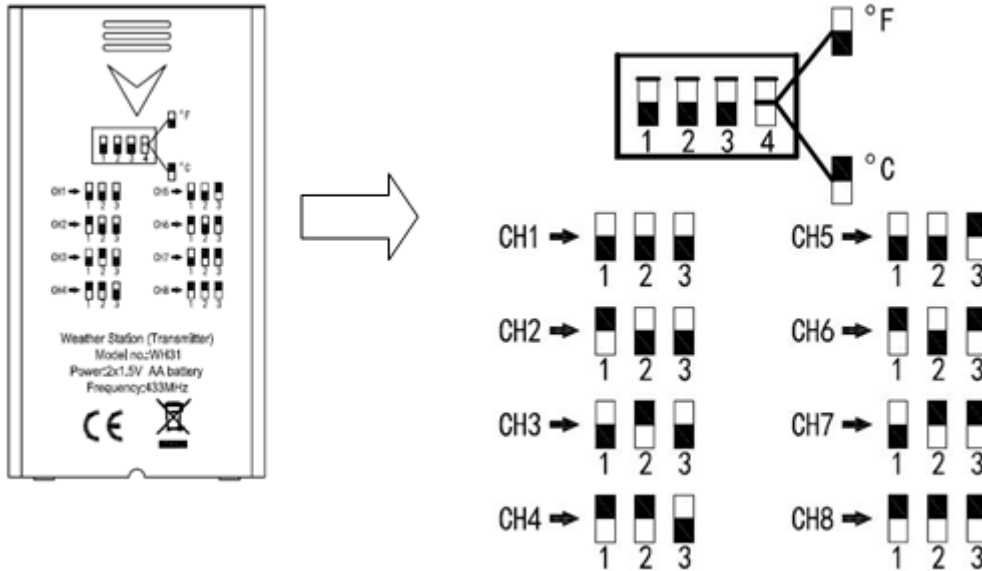

Figure 3

5. Insert (2) AA batteries.
6. Verify the correct channel number (CH) and temperature units of measurement (°F vs. °C) are on the display, as shown in Figure 4.

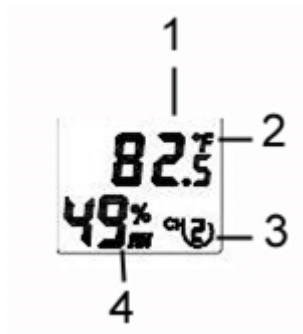

Figure 4

- (1) Temperature
- (2) Temperature Units (°F vs. °C)
- (3) Channel Number
- (4) Relative Humidity

7. Close the battery door.
8. Repeat for the additional remote transmitters, verifying each remote is on a different channel.

## 12.4 PM2.5 Air Quality Sensor (Optional)

The WS-2902D supports one indoor and one outdoor PM2.5 Air Quality sensor, and the console receives and sends this data directly to the Ambient Weather Network. The data is not displayed on the console (pass-through only) and cannot be calibrated.

For more information, please visit:

<https://ambientweather.com/ampm25.html>

## 12.5 Best Practices for Wireless Communication

Wireless communication is susceptible to interference, distance, walls, and metal barriers. We recommend the following



best practices for trouble-free wireless communication.

1. **Electro-Magnetic Interference (EMI):** Keep the console several feet away from computer monitors and TVs.
2. **Radio Frequency Interference (RFI):** If you have other 915 MHz devices and communication is intermittent, try turning off these other devices for troubleshooting purposes. You may need to relocate the transmitters or receivers to avoid intermittent communication.
3. **Line of Sight Rating:** This device is rated at 300 feet line of sight (no interference, barriers, or walls), but typically you will get 100 feet maximum. [This is under most real-world installations, which include passing through barriers or walls].
4. **Metal Barriers:** Radio frequency will not pass through metal barriers, such as aluminum siding. If you have metal siding, align the remote and console through a window to get a clear line of sight.

The following is a table of reception loss, versus the transmission medium. Each “wall” or obstruction decreases the transmission range by the factor shown below:







Medium	RF Signal Strength Reduction
Glass (Untreated)	5-15%
Plastic	10-15%
Wood	10-40%
Brick	10-40%
Concrete	40-80%
Metal	90-100%





## 13 Display Console Operation

### 13.1 Set Mode

Press and hold the [SET] button for two seconds to enter the SET Mode. To proceed to the next setting, press (do not hold) the [SET] button.

Figure summarizes the set mode sequence and commands:

Command	Mode	Settings	Image
[SET] + 2 seconds	Enter Set Mode, Beep On or Off	<p>Press [WIND +] to switch OFF and ON.</p> <p>This will prevent the beep from sounding when pressing any button.</p>	
[SET]	Clear Max/Min	<p>Press [WIND +] to switch OFF and ON.</p> <p>When set to ON, the minimum and maximum values reset every day at midnight (00:00).</p> <p>When set to OFF, the minimum and maximum values must be reset manually.</p>	
[SET]	Daylight Savings Time (DST)	<p>Press [WIND +] to switch DST OFF and ON.</p> <p>Set to ON (most locations) if you observe daylight savings time, and the clock will automatically adjust twice per year.</p> <p>Set to OFF (Arizona and Hawaii) if you do not observe DST.</p>	
[SET]	Time Zone	<p>Press [WIND +] or [PRESSURE -] to adjust up or down (-12 to 12).</p> <p>The default time zone is -5 (EST).</p> <p>To find your time zone settings, please reference Figure 5.</p>	
[SET]	12 hour / 24 Hour Format	Press [WIND +] to switch the hour format between 12-hour and 24-hour format.	
[SET]	Hour	Press [WIND +] or [PRESSURE -] to adjust the hour up or down.	
[SET]	Minute	Press [WIND +] or [PRESSURE -] to adjust the minute up or down.	
[SET]	Date Format	Press [WIND +] to switch between MM-DD (month-day) and DD-MM (day-month).	
[SET]	Year	Press [WIND +] or [PRESSURE -] to adjust the year up or down.	
[SET]	Month	Press [WIND +] or [PRESSURE -] to adjust the month up or down.	
[SET]	Day	Press [WIND +] or [PRESSURE -] to adjust the day up or down.	
[SET]	Pressure Units of Measure	Press [WIND +] to change units of measurement between hpa, mmHg or inHg.	
[SET]	Relative Pressure Calibration	<p>Press [WIND +] or [PRESSURE -] to adjust the relative pressure up or down.</p> <p>Reference Section 13.2.4 for details on calibration of relative pressure.</p>	
[SET]	Light Units of Measurement	Press [WIND +] to change light units of measurement between lux, fc, or w/m2.	

[SET]	Temperature Units of Measurement	Press [WIND +] to change temperature units of measurement between °F and °C.	
[SET]	Wind Units of Measurement	Press [WIND +] to change wind units of measurement between km/h, mph, knots, m/s and bft.	
[SET]	Rain Units of Measurement	Press [WIND +] to change rain units of measure between in and mm.	
[SET]	Hemisphere	Press [WIND +] to change hemisphere between NTH (Northern) and STH (Southern). This setting effects the moon phase display.	
[SET]	Exit Set Mode	Press the [LIGHT / SNOOZE] button to exit the SET mode.	

\*[SET] + 2 seconds means press and hold the SET button for two seconds.

\*[SET] means press the SET button.

Figure 19

### 13.1.1 Time Zones

The following table summarizes time zones around the world:

Hours from GMT	Time Zone	Cities
-12	IDLW: International Date Line West	---
-11	NT: Nome	Nome, AK, USA
-10	AHST: Alaska-Hawaii Standard CAT: Central Alaska HST: Hawaii Standard	Honolulu, HI, USA
-9	YST: Yukon Standard	Yukon Territory
-8	PST: Pacific Standard	Los Angeles, CA, USA
-7	MST: Mountain Standard	Denver, CO, USA
-6	CST: Central Standard	Chicago, IL, USA
-5	EST: Eastern Standard	New York, NY, USA
-4	AST: Atlantic Standard	Caracas, Venezuela
-3	---	São Paulo, Brazil
-2	AT: Azores	Azores, Cape Verde Islands
-1	WAT: West Africa	---
0	GMT: Greenwich Mean WET: Western European	London, England
1	CET: Central European	Paris, France
2	EET: Eastern European	Athens, Greece
3	BT: Baghdad	Moscow, Russia
4	---	Abu Dhabi, UAE
5	---	Tashkent, Uzbekistan
6	---	Astana, Kazakhstan
7	---	Bangkok, Thailand
8	CCT: China Coast	Beijing, China
9	JST: Japan Standard	Tokyo, Japan

Hours from GMT	Time Zone	Cities
10	GST: Guam Standard	Sydney, Australia
11	---	Magadan, Russia
12	IDLE: International Date Line East NZST: New Zealand Standard	Wellington, New Zealand

Figure 5

## 13.2 Barometric Pressure Display

### 13.2.1 Viewing Absolute vs. Relative Pressure

To switch between absolute and relative pressure, press and hold the [PRESSURE -] button for two seconds.

Absolute pressure is the measured atmospheric pressure, and is a function of altitude, and to a lesser extent, changes in weather conditions.

Absolute pressure is not corrected to sea-level conditions.

Relative pressure is corrected to sea-level conditions. For further discussion of relative pressure and calibration, reference Section 13.2.4.

### 13.2.2 Rate of Change of Pressure Graph

The rate of change of pressure graphic is shown to the left of the barometric pressure and signifies the difference between the daily average pressure and the 30-day average (in hPa).



Figure 6

### 13.2.3 Viewing Pressure History

Press the [PRESSURE -] button to view the 12-hour, 24-hour, 48 hour, and 72-hour pressure averages.

### 13.2.4 Relative Pressure Calibration Discussion

To compare pressure conditions from one location to another, meteorologists correct pressure to sea-level conditions (SSL). Because the air pressure decreases as you rise in altitude, the sea-level corrected pressure (the pressure your location would be at if located at sea-level) is generally higher than your measured pressure.

Thus, your absolute pressure may read 28.62 inHg (969 mb) at an altitude of 1000 feet (305 m), but the relative pressure is 30.00 inHg (1016 mb).

The standard sea-level pressure is 29.92 inHg (1013 mb). This is the average sea-level pressure around the world. Relative

pressure measurements greater than 29.92 inHg (1013 mb) are considered high pressure and relative pressure measurements less than 29.92 inHg are considered low pressure.

To determine the relative pressure for your location, locate your local “official” barometric pressure reading on [www.AmbientWeather.net/baro](http://www.AmbientWeather.net/baro) or scan the QR code below. To access the relative pressure calibration screen of your console, see Section 13.8.1 / Figure 25 to enter the value.



**Note:** The calibration setting is saved until the console is factory reset. If the console location/elevation changes, it will need to be recalibrated.

## 13.3 Rain Display

### 13.3.1 Rain Increments of Measure

Press the [RAIN] button to switch between Rain Rate (in/hr), Rain Event, Rain Day, Rain Week, Rain Month, and Rain Total.

### 13.3.2 Resetting Rain

Display the increment of rain you wish to clear, as shown in Section 13.3.1.

To reset the rain totals, press and hold the [RAIN] button for two seconds.

- Resetting the weekly rain also resets the daily rain.
- Resetting the monthly rain also resets the daily and weekly rain.
- Resetting the total rain also resets the monthly, weekly, and daily rain.

### 13.3.3 Increments of Rain Definitions

- **Rain rate or hourly rain** is defined as the last 10 minutes of rainfall, multiplied by six (10 minutes x 6 = 1 hour). This is also referred to as instantaneous rain per hour.
- **Rain event** is defined as continuous rain and resets to zero if rainfall accumulation is less than 10 mm (0.039 in) in a 24-hour period.
- **Daily Rain** is defined as the rainfall since midnight (00:00).
- **Weekly Rain** is defined as the calendar week total and resets on Sunday morning at midnight (Sunday through Saturday).
- **Monthly Rain** is defined as the calendar month total and resets on the first day of the month.
- **Total Rain** is defined as the running total since the station was last powered up.

## 13.4 Wind Display

Press the [WIND +] button to switch between average wind speed, wind gust, and wind direction.

- Wind speed is defined as the average wind speed in the 16-second update period.
- Wind gust is defined as the peak wind speed in the 16-second update period.

## 13.5 Temperature Display

If the temperature is lower than minimum range, the temperature field will display dashes (--.-).

If the temperature is higher than maximum range, the temperature field will display dashes (--.-).

### 13.5.1 Wind Chill, Dew Point, and Heat Index Display

Press the [TEMP] button to switch between Outdoor Temperature, Wind Chill, Heat Index, Dew Point.

## 13.6 Alarms

### 13.6.1 Viewing High and Low Alarms

To view the high alarm settings, press (do not hold) the [ALARM] button, and the high alarms will be displayed, as shown in Figure 7 (a).

To view the low alarm settings, press the [ALARM] button again, and the low alarms will be displayed, as shown in Figure 7 (b).

To return to normal mode, press the [ALARM] button again.

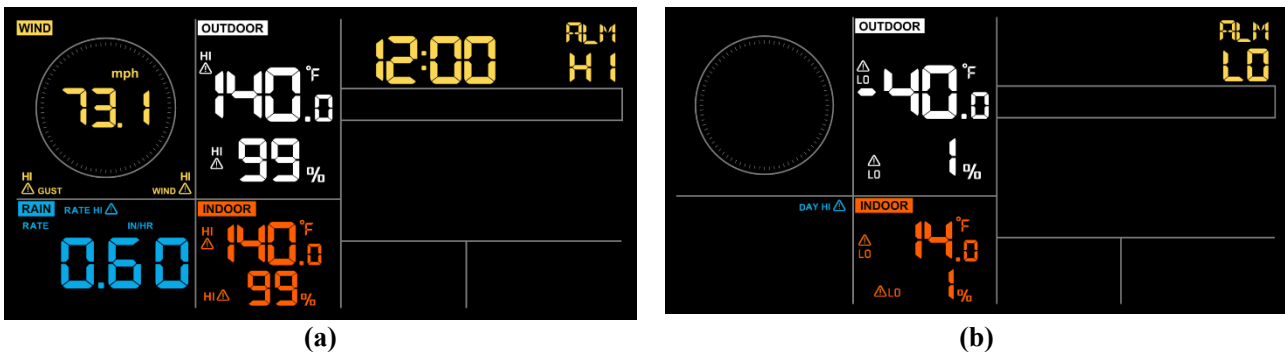

Figure 7

#### 13.6.1.1 Rain Alarm

While the High Alarm is displayed (reference Section 13.6.1), press the [RAIN] button to display the rain rate and daily rain alarm values.



#### 13.6.1.2 Wind Alarm







While the High Alarm is displayed (reference Section 13.6.1), press the [WIND] button to display the wind speed and wind gust alarm values.

### 13.6.2 Setting High and Low Alarms







Press and hold the [ALARM] button for two seconds to enter the ALARM Set Mode. To save and proceed to the next alarm setting, press (do not hold) the SET button.

Figure 8 summarizes the alarm mode sequence and commands.

Command	Mode	Settings
[ALARM] + 2 seconds	Enter Alarm Set Mode, Alarm Hour	<p>Press [WIND +] or [PRESSURE -] to adjust the alarm hour up or down.</p> <p>Press [ALARM] to turn the time alarm on or off. When the alarm is on, the alarm time icon  will appear.</p>
[SET]	Alarm Minute	<p>Press [WIND +] or [PRESSURE -] to adjust the alarm minute up or down.</p> <p>Press [ALARM] to turn the time alarm on. The alarm time icon  will appear.</p> <p>Press [ALARM] again to turn the time alarm off. The alarm time icon will disappear.</p>

[SET]	Alarm High Indoor Temperature	<p>Press [WIND +] or [PRESSURE -] to adjust the alarm value up or down.</p> <p>Press [ALARM] to turn the alarm on. The alarm icon  will appear.</p> <p>Press [ALARM] to turn the alarm off. The alarm icon will disappear.</p>
[SET]	Alarm Low Indoor Temperature	<p>Press [WIND +] or [PRESSURE -] to adjust the alarm value up or down.</p> <p>Press [ALARM] to turn the alarm on. The alarm icon  will appear.</p> <p>Press [ALARM] to turn the alarm off. The alarm icon will disappear.</p>
[SET]	Alarm High Indoor Humidity	<p>Press [WIND +] or [PRESSURE -] to adjust the alarm value up or down.</p> <p>Press [ALARM] to turn the alarm on. The alarm icon  will appear.</p> <p>Press [ALARM] to turn the alarm off. The alarm icon will disappear.</p>
[SET]	Alarm Low Indoor Humidity	<p>Press [WIND +] or [PRESSURE -] to adjust the alarm value up or down.</p> <p>Press [ALARM] to turn the alarm on. The alarm icon  will appear.</p> <p>Press [ALARM] to turn the alarm off. The alarm icon will disappear.</p>
[SET]	Alarm High Outdoor Temperature	<p>Press [WIND +] or [PRESSURE -] to adjust the alarm value up or down.</p> <p>Press [ALARM] to turn the alarm on. The alarm icon  will appear.</p> <p>Press [ALARM] to turn the alarm off. The alarm icon will disappear.</p>
[SET]	Alarm Low Outdoor Temperature	<p>Press [WIND +] or [PRESSURE -] to adjust the alarm value up or down.</p> <p>Press [ALARM] to turn the alarm on. The alarm icon  will appear.</p> <p>Press [ALARM] to turn the alarm off. The alarm icon will disappear.</p>



[SET]	Alarm High Outdoor Humidity	<p>Press [WIND +] or [PRESSURE -] to adjust the alarm value up or down.</p> <p>Press [ALARM] to turn the alarm on. The alarm icon  will appear.</p> <p>Press [ALARM] to turn the alarm off. The alarm icon will disappear.</p>
[SET]	Alarm Low Outdoor Humidity	<p>Press [WIND +] or [PRESSURE -] to adjust the alarm value up or down.</p> <p>Press [ALARM] to turn the alarm on. The alarm icon  will appear.</p> <p>Press [ALARM] to turn the alarm off. The alarm icon will disappear.</p>
[SET]	Alarm High Wind Speed	<p>Press [WIND +] or [PRESSURE -] to adjust the alarm value up or down.</p> <p>Press [ALARM] to turn the alarm on. The alarm icon  will appear.</p> <p>Press [ALARM] to turn the alarm off. The alarm icon will disappear.</p>
[SET]	Alarm High Wind Gust	<p>Press [WIND +] or [PRESSURE -] to adjust the alarm value up or down.</p> <p>Press [ALARM] to turn the alarm on. The alarm icon  will appear.</p> <p>Press [ALARM] to turn the alarm off. The alarm icon will disappear.</p>
[SET]	Alarm High Rain Rate	<p>Press [WIND +] or [PRESSURE -] to adjust the alarm value up or down.</p> <p>Press [ALARM] to turn the alarm on. The alarm icon  will appear.</p> <p>Press [ALARM] to turn the alarm off. The alarm icon will disappear.</p>
[SET]	Alarm High Daily Rain	<p>Press [WIND +] or [PRESSURE -] to adjust the alarm value up or down.</p> <p>Press [ALARM] to turn the alarm on. The alarm icon  will appear.</p> <p>Press [ALARM] to turn the alarm off. The alarm icon will disappear.</p>
[SET]	Exit alarm settings mode.	Press the [LIGHT / SNOOZE] button to exit the ALARM Set Mode.

\*[ALARM] + 2 seconds means press and hold the [ALARM] button for two seconds.

\*[ALARM] means press the [ALARM] button.

**Figure 8**

## 13.7 Max/Min Mode

### 13.7.1 Viewing Max/Min Values

To view the maximum value, press (do not hold) the [MAX/MIN] button, and the maximum values will be displayed, as shown in Figure 9 (a). To clear the maximum values, press and hold the [MAX/MIN] button while the maximum values are displayed.

To view the low alarm settings, press the [MAX/MIN] button again, and the minimum values will be displayed, as shown in Figure 9 (b). To clear the minimum values, press and hold the [MAX/MIN] button while the minimum values are displayed.

To return to normal mode, press the [MAX/MIN] button again.

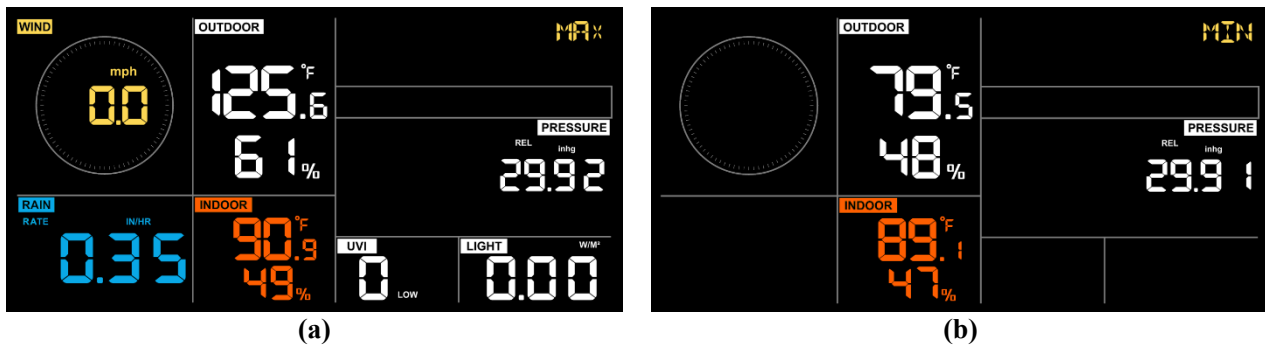

Figure 9

#### 13.7.1.1 Display Wind Chill, Heat Index, or Dew Point Max/Min Values

While the **maximum values** are displayed as outlined in Section 13.7.1, press the [TEMP] button once to view the heat index, twice to view the dew point, and a third time to return to outdoor temperature.

While the **minimum values** are displayed as outlined in Section 13.7.1, press the [TEMP] button once to view the wind chill, twice to view the dew point, and a third time to return to outdoor temperature.

#### 13.7.1.2 Display Wind Speed vs. Wind Gust Max Values

While the **maximum values** are displayed as outlined in Section 13.7.1, press the [WIND +] button once to view the maximum wind gust and twice to return to wind speed.

#### 13.7.1.3 Display Rain Rate, Daily Rain, Weekly Rain, and Monthly Rain Max Values

While the **maximum values** are displayed as outlined in Section 13.7.1, press the [RAIN] button once to view the maximum daily rain, twice to view the maximum weekly rain, three times to view the maximum monthly rain rate, or four times to return to the maximum rain rate.

#### 13.7.1.4 Display Absolute and Relative Pressure Min and Max Values

While the **max values** are displayed as outlined in Section 13.7.1, press and hold the [PRESSURE] button for two seconds to view the absolute pressure, and press and hold the [PRESSURE] button for two seconds again to return to relative pressure.

While the **minimum values** are displayed as outlined in Section 13.7.1, press and hold the [PRESSURE] button for two seconds to view the absolute pressure, and press and hold the [PRESSURE] button for two seconds again to return to relative pressure.

## 13.8 Calibration

### 13.8.1 Calibration Settings

Press and hold the [TEMP] and [MAX/MIN] buttons at the same time for 5 seconds to enter calibration mode. The CAL icon will be displayed.

To proceed to the next calibration setting, press (do not hold) the [SET] button.

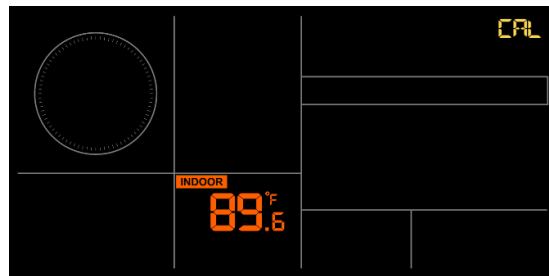

Figure 10

Figure 11 summarizes the set mode sequence and commands.

Command	Mode	Settings
<b>TEMP. and MAX/MIN + 5 seconds</b>	Enter Calibration Mode, Indoor Temperature	Press [WIND +] or [PRESSURE -] to adjust the indoor temperature up or down.  To restore to factory default settings, press [ALARM].
[SET]	Indoor Humidity	Press [WIND +] or [PRESSURE -] to adjust the indoor humidity up or down.  To restore to factory default settings, press [ALARM].
[SET]	Outdoor Temperature	Press [WIND +] or [PRESSURE -] to adjust the outdoor temperature up or down.  To restore to factory default settings, press [ALARM].
[SET]	Outdoor Humidity	Press [WIND +] or [PRESSURE -] to adjust the outdoor humidity up or down.  To restore to factory default settings, press [ALARM].
[SET]	Absolute Pressure	Press [WIND +] or [PRESSURE -] to adjust the absolute pressure up or down.  To restore to factory default settings, press [ALARM].  <b>Note:</b> The absolute pressure calibration affects the relative pressure by the same amount. It is recommended you calibrate the relative pressure only, per Section 13.1.
[SET]	Wind Direction	Press [WIND +] or [PRESSURE -] to adjust the wind direction up or down.  To restore to factory default settings, press [ALARM].
[SET]	Wind Speed Factor	Press [WIND +] or [PRESSURE -] to adjust the wind speed factor up or down.  To restore to factory default settings, press [ALARM].
[SET]	Rain Factor	Press [WIND +] or [PRESSURE -] to adjust the rain factor up or down.  To restore to factory default settings, press [ALARM].
[SET]*	Daily Rain	Press [WIND +] or [PRESSURE -] to adjust the daily rain up or down.
[SET]*	Monthly Rain	Press [WIND +] or [PRESSURE -] to adjust the monthly rain up or down.
[SET]*	Yearly Rain	Press [WIND +] or [PRESSURE -] to adjust the yearly rain up or down.
[SET]*	Total Rain	Press [WIND +] or [PRESSURE -] to adjust the total rain up or down.
[SET]	Exit calibration mode	Press the [LIGHT / SNOOZE] button to save the settings and exit calibration mode.

**Figure 11**

\* Command unavailable in earlier models.

### 13.8.2 Calibration Ranges

The following table summarizes the permissible calibration ranges:

Parameter	Range
Indoor Temperature	± 9 °F
Indoor Humidity	± 9%
Outdoor Temperature	± 9 °F
Outdoor Humidity	± 9%
Absolute Pressure	± 10 hpa (± 2.95 inHg)
Wind Direction	± 180 °
Wind Speed Factor	0.5 to 1.5
Rain Factor	0.5 to 1.5

**Figure 12**

### 13.8.3 Calibration Discussion

The purpose of calibration is to fine tune or correct for any sensor error associated with the device’s margin of error. Errors can occur due to electronic variation (i.e., the temperature sensor is a resistive thermal device or RTD, and the humidity sensor is a capacitance device), mechanical variation, or degradation (i.e., wearing of moving parts or contamination of sensors).

Calibration is only useful if you have a known calibrated source that you can compare it against. This section discusses practices, procedures, and sources for sensor calibration to reduce manufacturing and degradation errors. Do not compare data to findings obtained from sources such as the internet, radio, television, or newspapers. The purpose of your weather station is to measure conditions of your surroundings, which vary significantly from location to location.

Parameter	Type of Calibration	Default	Typical Calibration Source
Temperature	Offset	Current Value	Red Spirit or Mercury Thermometer (1)
Humidity	Offset	Current Value	Sling Psychrometer (2)
ABS Barometer	Offset	Current Value	Calibrated Laboratory-Grade Barometer
REL Barometer	Offset	Current Value	Local Airport (3)
Wind Direction	Offset	Current Value	GPS, Compass (4)
Wind	Gain	1.00	Calibrated Laboratory-Grade Wind Meter (5)
Rain	Gain	1.00	Sight Glass Rain Gauge with an aperture of at least 4” (6)

**Figure 28**

- (1) Temperature errors can occur when a sensor is placed too close to a heat source (such as a building/structure, the ground, or trees).

To calibrate temperature, we recommend a mercury or red spirit (fluid) thermometer. Bi-metal (dial) and digital thermometers (from other weather stations) are not a good source and have their own margin of error. Using a local weather station in your area is also a poor source due to changes in location and timing (airport weather stations are only updated once per hour).

Place the sensor in a shaded, controlled environment next to the fluid thermometer and allow the sensor to stabilize for 48 hours. Compare this temperature to the fluid thermometer and adjust the console to match the fluid thermometer.

- (2) Humidity is a difficult parameter to measure electronically and drifts over time due to contamination. In addition, location has an adverse effect on humidity readings (installation over dirt vs. a lawn, for example).

Official stations recalibrate or replace humidity sensors on a yearly basis. Due to manufacturing tolerances, the humidity is accurate to ± 5%. To improve this accuracy, the indoor and outdoor humidity can be calibrated using an accurate source, such as a sling psychrometer.

- (3) The display console displays two different pressures: absolute (measured) and relative (corrected to sea-level).

To compare pressure conditions from one location to another, meteorologists correct pressure to sea-level conditions. Because air pressure decreases as you rise in altitude, the sea-level corrected pressure (the pressure your location would be at if located at sea-level) is generally higher than your measured pressure.

Thus, your absolute pressure may read 28.62 inHg (969 mb) at an altitude of 1000 feet (305 m), but the relative pressure is 30.00 inHg (1016 mb).

The standard sea-level pressure is 29.92 in Hg (1013 mb). This is the average sea-level pressure around the world. Relative pressure measurements greater than 29.92 inHg (1013 mb) are considered high pressure, and relative pressure measurements less than 29.92 inHg are considered low pressure.

To determine the relative pressure for your location, locate your local “official” barometric pressure reading on [www.AmbientWeather.net/baro](http://www.AmbientWeather.net/baro) or scan QR code below. To access the pressure relative pressure calibration screen of your console, see Section 13.8.1 / Figure 25 to enter the value.



**Note: Calibration setting is saved until console is factory reset. If the console location elevation changes, it will need to be recalibrated.**

- (4) Only use this if you improperly installed the weather station sensor array and did not point the direction reference to true north.
- (5) Wind speed is the most sensitive to installation constraints. The guideline for properly installing a wind speed sensor is 4 x the distance of the tallest obstruction. For example, if your house is 20’ tall and you mount the sensor on a 5’ pole:

$$\text{Distance} = 4 \times (20 - 5) = 60'$$

Many installations are not perfect, and installing the weather station on a roof can be difficult. Thus, you can calibrate for this error with a wind speed multiplier.

In addition to the installation challenges, wind cup bearings (moving parts) wear over time.

Without a calibrated source, wind speed can be difficult to measure. We recommend using a calibrated wind meter (available from Ambient Weather) and a consistent, high speed fan.

- (6) The rain collector is calibrated at the factory based on the funnel diameter. The bucket tips every 0.01” of rain (referred to as resolution). The accumulated rainfall can be compared to a sight glass rain gauge with an

aperture of at least 4". The following is a link to an accurate sight glass rain gauge:

<http://www.ambientweather.com/stpraga.html>

Make sure that you periodically clean the rain gauge funnel.

## 14 Mounting Pole Installation

Reference Figure 213. The mounting assembly includes two U-Bolts and a bracket that tightens around a 1" to 2" diameter pole (not included) using the (4) U-Bolt nuts.

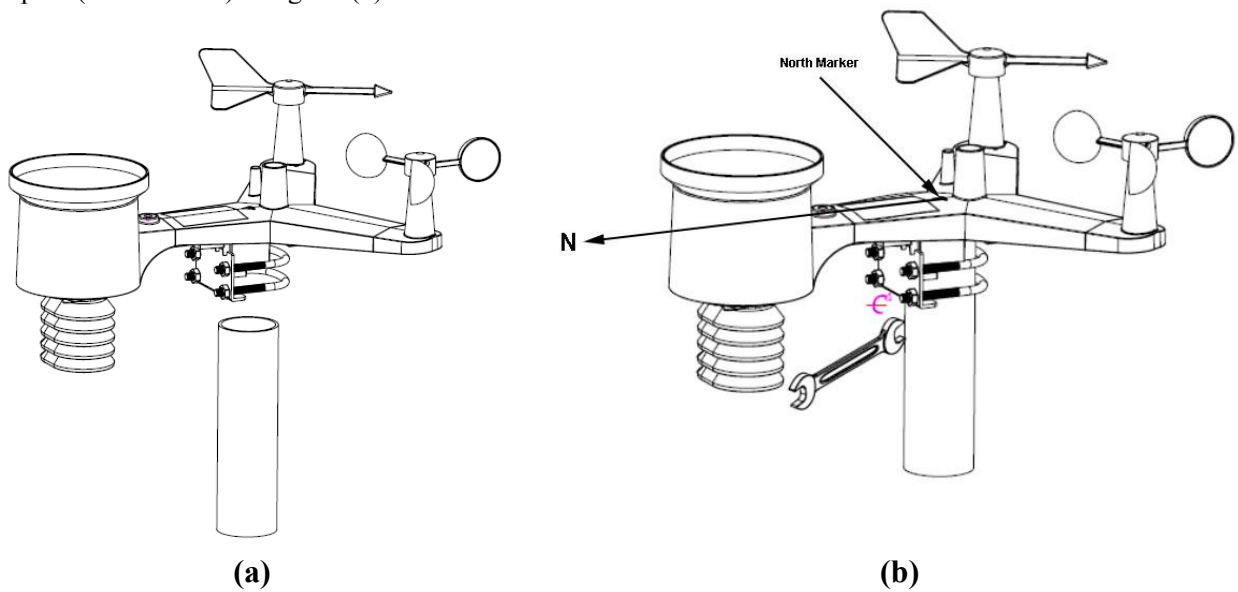



Figure 213

Use the bubble level next to the rain sensor to make sure the sensor array is completely level. If the sensor array is not level, the rain gauge, UV, and solar radiation sensors will not measure properly.

 **Note:** If you cannot read the bubble level due to mounting constraints, place a line or ruler level across the top of the rain gauge for easier viewing.

### 14.1 Pre-Installation Checkout

Before installing your weather station in the permanent location, we recommend operating the weather station for one week in a temporary location with easy access. This will allow you to check out all the functions, ensure proper operation, and familiarize yourself with the weather station and calibration procedures.

## 14.2 Site Survey

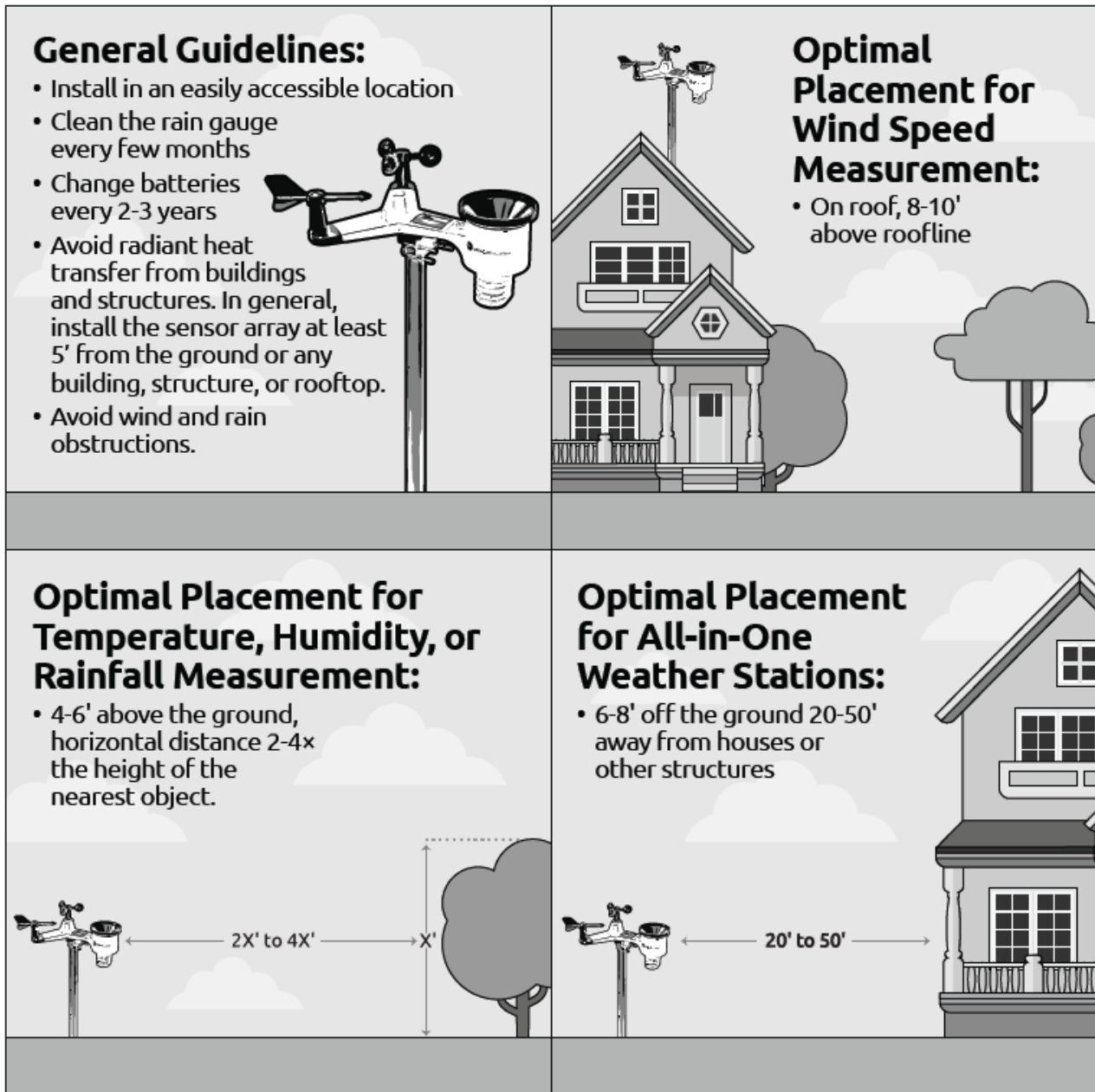

Perform a site survey before installing the weather station. Consider the following:

1. You must clean the rain gauge every few months and change the batteries every 2-3 years. Ensure easy access to the weather station.
2. Avoid radiant heat transfer from buildings and structures. In general, install the sensor array at least 5' from any building, structure, ground, or rooftop.
3. Avoid wind and rain obstructions. Install the sensor array at least four times the distance of the height of the tallest obstruction. For example, if the building is 20' tall and the mounting pole is 6' tall, install the sensor array  $4 \times (20 - 6) = 56'$  away.
4. Mount the sensor array in direct sunlight for accurate temperature readings.
5. Installing the weather station over sprinkler systems or other unnatural vegetation may affect temperature and humidity readings. We suggest mounting the sensor array over natural vegetation.
6. **Wireless Range.** Radio communication between a receiver and a transmitter in an open field can reach up to 330 feet, providing there are no interfering obstacles such as buildings, trees, vehicles, or high voltage lines. Wireless signals will not penetrate metal buildings. Under most conditions, the maximum wireless range is 100'.
7. **Radio Interference.** Computers, radios, televisions, and other sources can interfere with radio communications between the sensor array and console. Please take this into consideration when choosing console or mounting



locations. Make sure your display console is at least five feet away from any electronic device to avoid interference.

8. Visit Ambient Weather Mounting Solutions for assistance and ideas for mounting your weather station:

<https://ambientweather.com/faqs/question/view/id/1788/>

## 14.3 Install U-Bolts

Note: Your U-bolts may have come preassembled at the factory.

- (a) Insert the U-Bolts into the Sensor Array mounting bracket and hand-tighten the nuts.
- (b) Tighten the nuts to fit the size of your mounting pole (between 1.25" and 2" diameter).

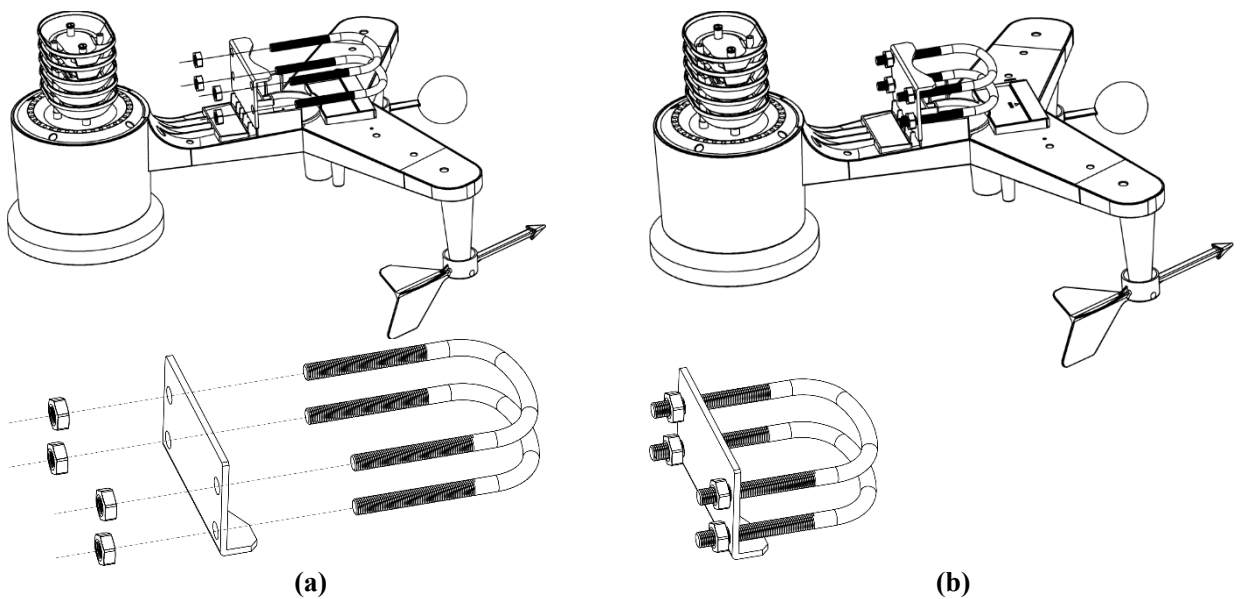

- (a) Insert the Sensor Array and U-Bolt assembly onto the mounting pole.
- (b) Tighten the U-Bolts around the pole with a 10mm wrench. Make sure the Sensor Array is level.

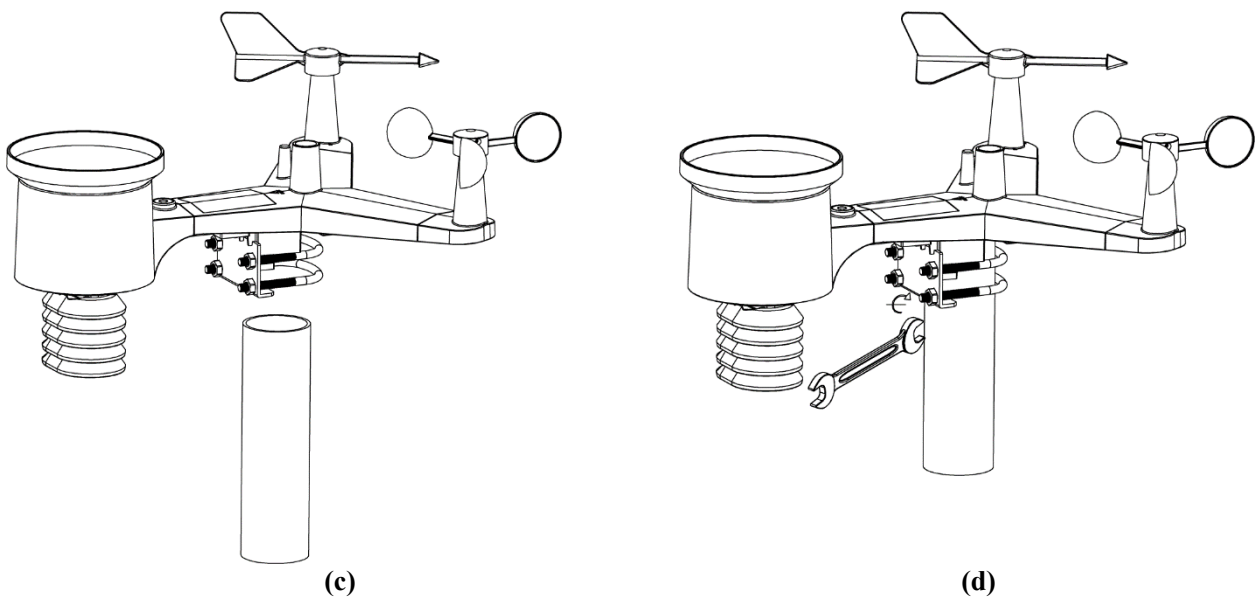

**Figure 29**

## 14.4 Aligning the Wind Direction

Locate the North (N) Marker on the top of the Sensor Array. Align the marker to point North upon final installation with a compass or GPS.

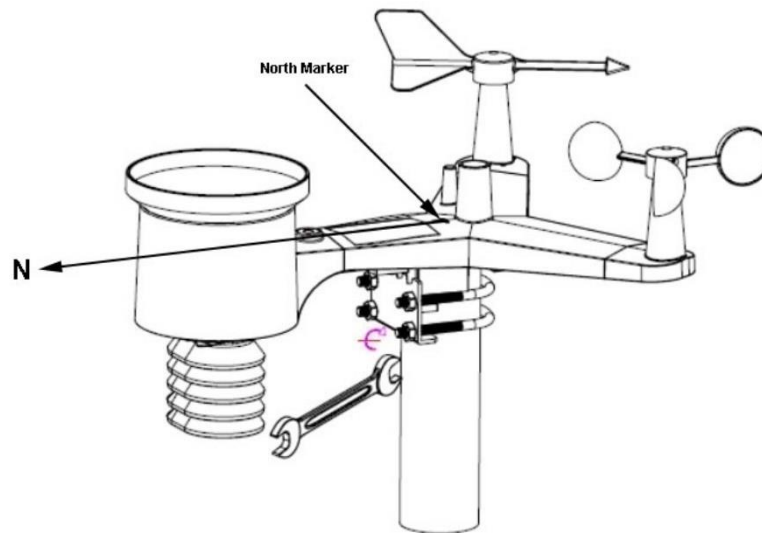

Figure 30

## 15 Restoring the Console to Factory Default

To restore the console to factory default, perform the following steps:

1. Remove the power from the console by removing the batteries and disconnecting the AC adapter.
2. Apply power by connecting the AC adapter.
3. Wait for all the segments to appear on the screen, as shown in Figure .
4. Press and hold the [WIND/+] and [PRESSURE/-] buttons at the same time until the console power-up sequence is complete (about 5 seconds).
5. Replace the batteries.

## 16 Resynchronizing the Wireless Sensor

Press and hold the [LIGHT/SNOOZE] button for 5 seconds, and the console will re-register the wireless sensor.

## 17 Backlight Operation

### 17.1 With AC Adapter

The backlight can only be continuously on when the AC adapter is permanently on. When the AC adapter is disconnected, the backlight can be temporarily turned on.

Press the [LIGHT/SNOOZE] button to adjust the brightness between High, Low, and Off.

### 17.2 Without AC Adapter

To reduce power consumption, the console will sleep on battery power only and will not send data to the Internet.

To temporarily turn on the back light for 15 seconds, press the [LIGHT/SNOOZE] button.

## 18 Tendency Arrows

Tendency arrows allow you to quickly determine if temperature or pressure are rising or falling in a three-hour update

period, updated every 30 minutes.

Figure defines the conditions for rising and falling pressure every 3 hours.



Tendency Indicators	Condition	Humidity Change Per 3 Hours	Temperature Change Per 3 Hours
	Rising	Rising > 3%	Rising > 1° C / 2 °F
	Steady	Change ≤ ±3%	Change ≤ ± 1 ° C / 2 ° F
	Falling	Falling > 3%	Falling > 1° C / 2 °F

Figure 31

## 19 Wireless Signal Quality Indicator

The wireless signal strength displays reception quality. When the signal is strong, the signal strength indicator will display 5 bars. As the signal weakens, four bars will be displayed, as shown in Figure , and so on.



Five Bars	Four Bars
	
No signal loss	Weakened Signal

Figure 32

## 20 Weather Forecasting

The six weather icons are Sunny, Partly Cloudy, Cloudy, Rainy, Stormy, and Snowy.

The forecast icon is based on the rate of change of barometric pressure. Please allow at least **one month** for the weather station to learn the barometric pressure over time.







Sunny	Partly Cloudy	Cloudy	Rainy	Stormy	Snowy
					
Pressure increases for a sustained period of time.	Pressure increases slightly (or initial power-up).	Pressure decreases slightly.	Pressure decreases for a sustained period of time.	Pressure rapidly decreases.	Pressure decreases for a sustained period of time, and temperature is below freezing.

Figure 33

### 20.1 Storm Alert

If there is a rapid drop in barometric pressure, the forecast icon will flash.

## 20.2 Weather Forecasting Description and Limitations

In general, if the rate of change of pressure increases, the weather is generally improving (sunny to partly cloudy). If the rate of change of pressure decreases, the weather is generally degrading (cloudy, rainy, or stormy). If the rate of change is relatively steady, it will read partly cloudy.

The reason the current conditions do not match the forecast icon is because the forecast is a prediction 24-48 hours in advance. In most locations, this prediction is only 70% accurate, and it is a good idea to consult the National Weather Service for more accurate weather forecasts. In some locations, this prediction may be less or more accurate. However, it is still an interesting educational tool for learning why the weather changes.

The National Weather Service (and other weather services such as Accuweather and The Weather Channel) have many tools at their disposal to predict weather conditions, including weather radar, weather models, and detailed mapping of ground conditions.

## 21 Live Internet Publishing

The WS-2902D sends data to three free hosting services:

Hosting Service	Website	Description
Ambient Weather Network	AmbientWeather.net	The Ambient Weather Network is the most user-friendly design for monitoring your data across different platforms. Quickly view detailed information with our animated, expandable modules. Our network supports email and text alerts.

The WS-2902D weather station sends data to the Internet using your Wi-Fi connection.

## 22 Glossary of Terms

Term	Definition
Absolute Barometric Pressure	Absolute pressure is the measured atmospheric pressure and is a function of altitude, and to a lesser extent, changes in weather conditions.  Absolute pressure is not corrected to sea-level conditions. <i>Refer to Relative Barometric Pressure.</i>
Accuracy	Accuracy is defined as the ability of a measurement to match the actual value of the quantity being measured.
Barometer	A barometer is an instrument used to measure atmospheric pressure.
Calibration	Calibration is a comparison between measurements – one of known magnitude or correctness of one device (standard), and another measurement made in as similar a way as possible with a second device (instrument).
Dew Point	The dew point is the temperature at which a given parcel of humid air must be cooled, at constant barometric pressure, for water vapor to condense into water. The condensed water is called dew. The dew point is a saturation temperature.  The dew point is associated with relative humidity. A high relative humidity indicates that the dew point is closer to the current air temperature. Relative humidity of 100% indicates that the dew point is equal to the current temperature, and the air is maximally saturated with water. When the dew point remains constant and temperature increases, relative humidity will decrease.
Heat Index	The Heat Index, sometimes referred to as the apparent temperature, is a measure of how hot it really feels when relative humidity is factored with the actual air temperature.  To find the Heat Index temperature, look at the Heat Index chart below. As an example, if the air temperature is 96°F and the relative humidity is 65%, the heat index (how hot it feels) is 121°F.

Term	Definition																																																																																																																																																																																																																																																														
	<p><b>IMPORTANT:</b> Since heat index values were devised for shady, light wind conditions, exposure to full sunshine can increase heat index values by up to 15°F. Also, strong winds, particularly with very hot, dry air can be extremely hazardous.</p> <p>The shaded zone above 105°F shows a level that may cause increasingly severe heat disorders with continued exposure or physical activity.</p> <p>Heat Index is not calculated below 80°F.</p> <div style="text-align: center;"> <p><b>Relative Humidity (%)</b></p> <table border="1" style="margin: auto;"> <thead> <tr> <th style="border: none;">°F</th> <th>40</th><th>45</th><th>50</th><th>55</th><th>60</th><th>65</th><th>70</th><th>75</th><th>80</th><th>85</th><th>90</th><th>95</th><th>100</th> </tr> </thead> <tbody> <tr><td style="border: none;">110</td><td>136</td><td></td><td></td><td></td><td></td><td></td><td></td><td></td><td></td><td></td><td></td><td></td><td></td></tr> <tr><td style="border: none;">108</td><td>130</td><td>137</td><td></td><td></td><td></td><td></td><td></td><td></td><td></td><td></td><td></td><td></td><td></td></tr> <tr><td style="border: none;">106</td><td>124</td><td>130</td><td>137</td><td></td><td></td><td></td><td></td><td></td><td></td><td></td><td></td><td></td><td></td></tr> <tr><td style="border: none;">104</td><td>119</td><td>124</td><td>131</td><td>137</td><td></td><td></td><td></td><td></td><td></td><td></td><td></td><td></td><td></td></tr> <tr><td style="border: none;">102</td><td>114</td><td>119</td><td>124</td><td>130</td><td>137</td><td></td><td></td><td></td><td></td><td></td><td></td><td></td><td></td></tr> <tr><td style="border: none;">100</td><td>109</td><td>114</td><td>118</td><td>124</td><td>129</td><td>136</td><td></td><td></td><td></td><td></td><td></td><td></td><td></td></tr> <tr><td style="border: none;">98</td><td>105</td><td>109</td><td>113</td><td>117</td><td>123</td><td>128</td><td>134</td><td></td><td></td><td></td><td></td><td></td><td></td></tr> <tr><td style="border: none;">96</td><td>101</td><td>104</td><td>108</td><td>112</td><td>116</td><td>121</td><td>126</td><td>132</td><td></td><td></td><td></td><td></td><td></td></tr> <tr><td style="border: none;">94</td><td>97</td><td>100</td><td>103</td><td>106</td><td>110</td><td>114</td><td>119</td><td>124</td><td>129</td><td>135</td><td></td><td></td><td></td></tr> <tr><td style="border: none;">92</td><td>94</td><td>96</td><td>99</td><td>101</td><td>105</td><td>108</td><td>112</td><td>116</td><td>121</td><td>126</td><td>131</td><td></td><td></td></tr> <tr><td style="border: none;">90</td><td>91</td><td>93</td><td>95</td><td>97</td><td>100</td><td>103</td><td>106</td><td>109</td><td>113</td><td>117</td><td>122</td><td>127</td><td>132</td></tr> <tr><td style="border: none;">88</td><td>88</td><td>89</td><td>91</td><td>93</td><td>95</td><td>98</td><td>100</td><td>103</td><td>106</td><td>110</td><td>113</td><td>117</td><td>121</td></tr> <tr><td style="border: none;">86</td><td>85</td><td>87</td><td>88</td><td>89</td><td>91</td><td>93</td><td>95</td><td>97</td><td>100</td><td>102</td><td>105</td><td>108</td><td>112</td></tr> <tr><td style="border: none;">84</td><td>83</td><td>84</td><td>85</td><td>86</td><td>88</td><td>89</td><td>90</td><td>92</td><td>94</td><td>96</td><td>98</td><td>100</td><td>103</td></tr> <tr><td style="border: none;">82</td><td>81</td><td>82</td><td>83</td><td>84</td><td>84</td><td>85</td><td>86</td><td>88</td><td>89</td><td>90</td><td>91</td><td>93</td><td>95</td></tr> <tr><td style="border: none;">80</td><td>80</td><td>80</td><td>81</td><td>81</td><td>82</td><td>82</td><td>83</td><td>84</td><td>84</td><td>85</td><td>86</td><td>86</td><td>87</td></tr> </tbody> </table> </div> <div style="margin-left: 20px;"> <p><b>Heat Index (Apparent Temperature)</b></p> <table border="1" style="margin-left: 20px;"> <thead> <tr> <th colspan="2" style="background-color: #d9534f; color: white;">Extreme Danger</th> </tr> <tr> <td style="background-color: #d9534f; color: white;">Heat stroke or sunstroke highly likely</td> <td></td> </tr> <tr> <th colspan="2" style="background-color: #e67e22; color: white;">Danger</th> </tr> <tr> <td style="background-color: #e67e22; color: white;">Sunstroke, muscle cramps, and/or heat exhaustion likely</td> <td></td> </tr> <tr> <th colspan="2" style="background-color: #f1c40f; color: white;">Extreme Caution</th> </tr> <tr> <td style="background-color: #f1c40f; color: white;">Sunstroke, muscle cramps, and/or heat exhaustion possible</td> <td></td> </tr> <tr> <th colspan="2" style="background-color: #fff2cc; color: black;">Caution</th> </tr> <tr> <td style="background-color: #fff2cc; color: black;">Fatigue possible</td> <td></td> </tr> </thead></table> <p style="text-align: right; margin-right: 20px;"><b>With Prolonged Exposure and/or Physical Activity</b></p> </div>	°F	40	45	50	55	60	65	70	75	80	85	90	95	100	110	136													108	130	137												106	124	130	137											104	119	124	131	137										102	114	119	124	130	137									100	109	114	118	124	129	136								98	105	109	113	117	123	128	134							96	101	104	108	112	116	121	126	132						94	97	100	103	106	110	114	119	124	129	135				92	94	96	99	101	105	108	112	116	121	126	131			90	91	93	95	97	100	103	106	109	113	117	122	127	132	88	88	89	91	93	95	98	100	103	106	110	113	117	121	86	85	87	88	89	91	93	95	97	100	102	105	108	112	84	83	84	85	86	88	89	90	92	94	96	98	100	103	82	81	82	83	84	84	85	86	88	89	90	91	93	95	80	80	80	81	81	82	82	83	84	84	85	86	86	87	Extreme Danger		Heat stroke or sunstroke highly likely		Danger		Sunstroke, muscle cramps, and/or heat exhaustion likely		Extreme Caution		Sunstroke, muscle cramps, and/or heat exhaustion possible		Caution		Fatigue possible	
°F	40	45	50	55	60	65	70	75	80	85	90	95	100																																																																																																																																																																																																																																																		
110	136																																																																																																																																																																																																																																																														
108	130	137																																																																																																																																																																																																																																																													
106	124	130	137																																																																																																																																																																																																																																																												
104	119	124	131	137																																																																																																																																																																																																																																																											
102	114	119	124	130	137																																																																																																																																																																																																																																																										
100	109	114	118	124	129	136																																																																																																																																																																																																																																																									
98	105	109	113	117	123	128	134																																																																																																																																																																																																																																																								
96	101	104	108	112	116	121	126	132																																																																																																																																																																																																																																																							
94	97	100	103	106	110	114	119	124	129	135																																																																																																																																																																																																																																																					
92	94	96	99	101	105	108	112	116	121	126	131																																																																																																																																																																																																																																																				
90	91	93	95	97	100	103	106	109	113	117	122	127	132																																																																																																																																																																																																																																																		
88	88	89	91	93	95	98	100	103	106	110	113	117	121																																																																																																																																																																																																																																																		
86	85	87	88	89	91	93	95	97	100	102	105	108	112																																																																																																																																																																																																																																																		
84	83	84	85	86	88	89	90	92	94	96	98	100	103																																																																																																																																																																																																																																																		
82	81	82	83	84	84	85	86	88	89	90	91	93	95																																																																																																																																																																																																																																																		
80	80	80	81	81	82	82	83	84	84	85	86	86	87																																																																																																																																																																																																																																																		
Extreme Danger																																																																																																																																																																																																																																																															
Heat stroke or sunstroke highly likely																																																																																																																																																																																																																																																															
Danger																																																																																																																																																																																																																																																															
Sunstroke, muscle cramps, and/or heat exhaustion likely																																																																																																																																																																																																																																																															
Extreme Caution																																																																																																																																																																																																																																																															
Sunstroke, muscle cramps, and/or heat exhaustion possible																																																																																																																																																																																																																																																															
Caution																																																																																																																																																																																																																																																															
Fatigue possible																																																																																																																																																																																																																																																															
HectoPascals (hPa)	Pressure units in SI (international system) units of measurement. Same as millibars (1 hPa = 1 mbar).																																																																																																																																																																																																																																																														
Hygrometer	A hygrometer is a device that measures relative humidity. Relative humidity is a term used to describe the amount or percentage of water vapor that exists in the air.																																																																																																																																																																																																																																																														
Inches of Mercury (inHg)	Pressure in Imperial units of measure. (1 inch of mercury = 33.86 millibars).																																																																																																																																																																																																																																																														
Rain Gauge	<p>A rain gauge is a device that measures liquid precipitation (rain), as opposed to solid precipitation (snow, hail, or ice) over a set period.</p> <p>All digital rain gauges are self-emptying or self-dumping (also referred to as tipping rain gauge). The precision of the rain gauge is based on the volume of rain per emptying cycle.</p>																																																																																																																																																																																																																																																														
Range	Range is defined as the amount or extent a value can be measured.																																																																																																																																																																																																																																																														
Relative Barometric Pressure	Measured barometric pressure relative to your location or ambient conditions.																																																																																																																																																																																																																																																														
Resolution	Resolution is defined as the number of significant digits (decimal places) to which a value is being reliably measured.																																																																																																																																																																																																																																																														
Solar Radiation	<p>A solar radiation sensor measures solar energy from the sun.</p> <p>Solar radiation is radiant energy emitted by the sun from a nuclear fusion reaction that creates electromagnetic energy. The spectrum of solar radiation is close to that of a black object with a temperature of about 5,800 K. About half of the radiation is in the visible short-wave part of the electromagnetic spectrum. The other half is mostly in the near-infrared part, with some in the ultraviolet part of the spectrum.</p>																																																																																																																																																																																																																																																														
Thermometer	A thermometer is a device that measures temperature. Most digital thermometers are resistive thermal devices (RTD). RTDs measure changes in temperature as a function of electrical resistance.																																																																																																																																																																																																																																																														
Wind Vane	A wind vane is a device that measures the direction of the wind. The wind vane is usually combined with the anemometer. Wind direction is the direction from which the wind is blowing.																																																																																																																																																																																																																																																														

**Figure 34**

## 23 Specifications

### 23.1 Wireless Specifications

- Line of sight wireless sensor array RF transmission (in open air): 330 feet, 100 feet under most conditions
- Line of sight Wi-Fi RF transmission (in open air): 80 feet
- Update Rate: Outdoor Sensor: 16 seconds, Indoor Sensor: 64 seconds
- Sensor Array RF Frequency: 915 MHz
- Wi-Fi Console RF Frequency: 2.4 GHz

### 23.2 Measurement Specifications

The following table provides the specifications for the measured parameters.

Measurement	Range	Accuracy	Resolution
Indoor Temperature	14 to 140 °F	± 2 °F	0.1 °F
Outdoor Temperature	-40 to 149 °F (lithium batteries) -23 to 140 °F (alkaline batteries)	± 2 °F	0.1 °F
Indoor Humidity	10 to 99%	± 5%	1 %
Outdoor Humidity	10 to 99%	± 5%	1 %
Barometric Pressure	8.85 to 32.50 inHg	± 0.08 inHg (within range of 27.13 to 32.50 inHg)	0.01 inHg
Light	0 to 200,000 Lux	± 15%	1 Lux
Rain	0 to 394 in.	± 5%	0.01 in
Wind Direction	0 - 360 °	± 10°	1°
Wind Speed	0 to 100 mph (operational)	± 2.2 mph or 10% (whichever is greater)	1.4 mph

**Figure 35**

### 23.3 Power Consumption

- Base Station: 5V DC Adaptor (included), Power Consumption: 0.5 Watts (1.25 Watts during Wi-Fi configuration mode)
- Base Station: (3) AAA batteries (not included)
- Outdoor Sensor Array: (3) AA batteries (not included). The primary power source is the solar panel. The batteries provide backup power when there is limited solar energy.

## 24 Maintenance

1. Clean the rain gauge once every 3 months. Rotate the funnel counterclockwise and lift to expose the rain gauge mechanism. Clean with a damp cloth. Remove any dirt, debris, or insects. If bug infestation is an issue, spray the array lightly with insecticide.

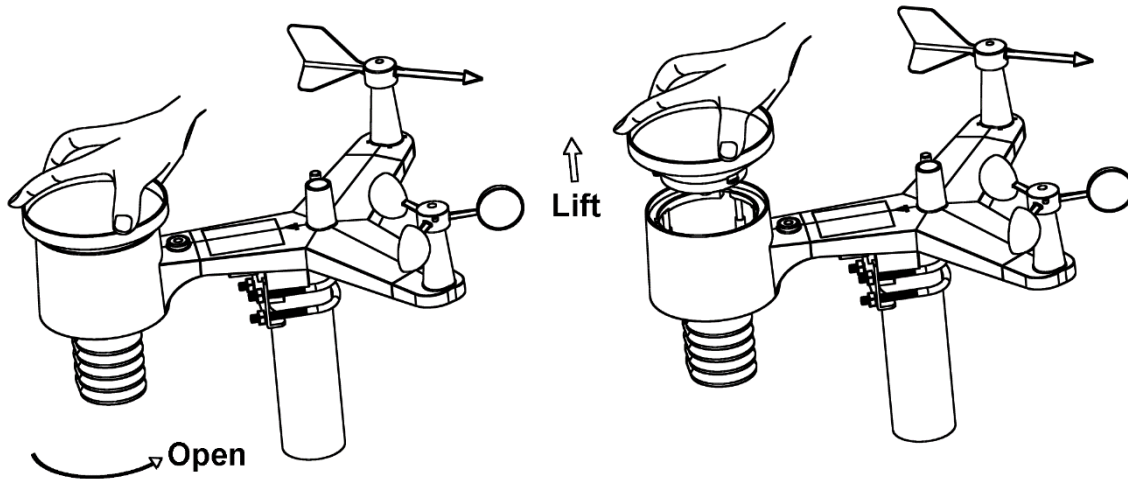

Figure 36

2. Clean the solar radiation sensor and solar panel every 3 months with a damp cloth.
3. Replace batteries every 1-2 years. If left in too long, the batteries may leak due to environmental challenges. In harsh environments, inspect the batteries every 3 months (when cleaning the solar panel).
4. When replacing the batteries, apply a corrosion preventive compound on the battery terminals, available at Amazon and most hardware stores.
5. In snowy environments, spray the top of the weather station with anti-icing silicone spray to prevent snow build-up.
6. Over time, the rain gauge funnel surface smoothness will decrease as a result of dirt, debris, and UV. We recommend spraying the rain gauge funnel and coil filter with Teflon spray to reduce water surface tension. For more information, visit:

<https://ambientweather.com/faqs/question/view/id/1447/>

## 25 Troubleshooting Guide

If your question is not answered here, you can contact us by phone or email:

1. Email Support: [support@ambientweather.com](mailto:support@ambientweather.com)
2. Technical Support: 480-346-3380 (M-F 8am to 3pm, Arizona Time)

Problem	Solution
Outdoor Sensor Array does not communicate to the display console.	<p>The sensor array may not have initiated properly, rendering the data registered by the console as invalid. In this case, the console must be reset. Press the [RESET] button as described in Figure .</p> <p>With an open-ended paperclip, press the [RESET] button for 3 seconds to completely discharge the voltage.</p> <p>Take out the batteries and wait one minute, while covering the solar panel to drain the voltage.</p> <p>Put batteries back in and resync the console (Section 7) with the sensor array about 10 feet away.</p> <p>The LED next to the battery compartment will flash every 16 seconds. If the LED is not flashing every 16 seconds, replace the batteries in the outside Sensor Array.</p>

Problem	Solution
	<p>If the batteries were recently replaced, check the polarity. If the sensor is flashing every 16 seconds, proceed to the next step.</p> <p>There may be a temporary loss of communication due to reception loss related to interference or other location factors.</p> <p>It is also possible that the batteries may have been changed in the Sensor Array or that the console was not reset. The solution may be as simple as powering down the console and restarting it. Note: Remove AC power and batteries, wait 10 seconds, and reinsert AC power and batteries.</p>
Temperature sensor reads too high in the daytime.	<p>Make certain that the Sensor Array is not too close to heat-generating sources or structures, such as buildings, pavement, walls, or air conditioning units.</p> <p>Use the calibration feature to offset installation issues related to radiant heat sources. Reference Section 13.8.</p>
Relative pressure does not agree with official reporting stations.	<p>You may be viewing the absolute pressure, not the relative pressure.</p> <p>Select the relative pressure. Make sure you properly calibrate the sensor to an official local weather station. Reference Section 13.2.4 for details.</p>
Rain gauge reports rain when it is not raining.	<p>An unstable mounting solution (sway in the mounting pole) may result in the tipping bucket incorrectly incrementing rainfall. Make sure you have a stable, level mounting solution.</p>
No Wi-Fi connection.	<ol style="list-style-type: none"> <li>1. Check for Wi-Fi symbol on the display. If wireless connectivity is successful, the Wi-Fi icon  will be displayed in the time field.</li> <li>2. Make sure your modem Wi-Fi settings are correct (network name and password).</li> <li>3. Make sure the console is plugged into AC power. The console will not connect to Wi-Fi when powered by batteries only.</li> <li>4. The console only supports and connects to 2.4 GHz routers. If you own a 5 GHz router and it is a dual-band router, you will need to disable the 5 GHz band and enable the 2.4 GHz band.</li> <li>5. The console does not support guest networks.</li> </ol>
Wind Vane does not spin as freely as the Wind Cups.	<p>This is by design. The dampening prevents the Wind Vane from spinning with the slightest breeze, which will result in variable wind all the time. The added resistance allows the Wind Vane to <u>change direction with 2 – 3 mph, providing optimum wind direction tracking.</u></p>
Time off by increments of an hour, or date is off by one day.	<p>The time zone is entered incorrectly. Reference Section 13.1.</p>

**Figure 37**

## 26 Accessories

The following software and hardware accessories are available for this weather station at [www.AmbientWeather.com](http://www.AmbientWeather.com).

Accessory	Description
<a href="#">Ambient Weather Mounting Solutions</a>	Ambient Weather provides the most comprehensive mounting solutions for weather stations, including tripods, pole extensions, pole mounting kits, guy wires, ground stakes and more.
WS-2902D-CONSOLE-AC Display Console	Add as many display consoles as you like to your weather station.

**Figure 38**



---

## 27 Liability Disclaimer

Please help preserve the environment by returning used batteries to an authorized depot. Electrical and electronic wastes contain hazardous substances. Disposal of electronic waste in nature and/or on unauthorized grounds is damaging to the environment.

Reading the User Manual is highly recommended. The manufacturer and supplier cannot accept any responsibility for any incorrect readings or consequences that occur as a result of not closely reading the manual.

This product is designed for in-home use only. This product is not to be used for medical purposes or for public safety information.

The specifications of this product may change without prior notice.

This product is not a toy. Keep out of the reach of children.

No part of this manual may be reproduced without written authorization of the manufacturer.

Ambient, LLC WILL NOT ASSUME LIABILITY FOR INCIDENTAL, CONSEQUENTIAL, PUNITIVE, OR OTHER SIMILAR DAMAGES ASSOCIATED WITH THE OPERATION OR MALFUNCTION OF THIS PRODUCT.

## 28 FCC Statement

### Statement according to FCC part 15.19:

This device complies with part 15 of the FCC rules. Operation is subject to the following two conditions:

1. This device may not cause harmful interference.
2. This device must accept any interference received, including interference that may cause undesired operation.

### Statement according to FCC part 15.21:

Modifications not expressly approved by this company could void the user's authority to operate the equipment.

### Statement according to FCC part 15.105:

NOTE: This equipment has been tested and found to comply with the limits for a Class B digital device, pursuant to Part 15 of the FCC Rules. These limits are designed to provide reasonable protection against harmful interference in a residential installation. This equipment generates, uses, and can radiate radio frequency energy and, if not installed and used in accordance with the instructions, may cause harmful interference to radio communications.

However, there is no guarantee that interference will not occur in a particular installation. If this equipment does cause harmful interference to radio or television reception, which can be determined by turning the equipment off and on, the user is encouraged to try to correct the interference by one or more of the following measures:

- Reorient or relocate the receiving antenna.
- Increase the separation between the equipment and the receiver.
- Connect the equipment into an outlet on a circuit different from that to which the receiver is connected.
- Consult the dealer or an experienced radio/TV technician for help.

## 29 Warranty Information

Ambient, LLC provides a 1-year limited warranty on this product against manufacturing defects in materials and workmanship.

This limited warranty begins on the original date of purchase, is valid only on products purchased, and is only valid for the original purchaser of this product. To receive warranty service, the purchaser must contact Ambient, LLC for problem determination and service procedures.

Warranty service can only be performed by an Ambient, LLC. The original dated bill of sale must be presented upon request as proof of purchase to Ambient, LLC.

Your Ambient, LLC warranty covers all defects in material and workmanship with the following specified exceptions: (1) damage caused by accident, unreasonable use or neglect (lack of reasonable and necessary maintenance); (2) damage

resulting from failure to follow instructions contained in your owner's manual; (3) damage resulting from the performance of repairs or alterations by someone other than an authorized Ambient, LLC authorized service center; (4) units used for other than personal use; (5) applications and uses that this product was not intended; (6) the product's inability to receive a signal due to any source of interference or metal obstructions; and (7) extreme acts of nature, such as lightning strikes or floods.

This warranty covers only actual defects within the product itself and does not cover the cost of installation or removal from a fixed installation, normal set-up or adjustments, claims based on misrepresentation by the seller, or performance variations resulting from installation-related circumstances.

## 30 California Prop 65

**WARNING:** Use of the Ambient Weather Products can expose you to chemicals, including lead and lead compounds, which are known to the State of California to cause cancer and bisphenol A (BPA), and phthalates DINP and/or DEHP, which are known to the State of California to cause birth defects or other reproductive harm.

### Can I Trust that Ambient Weather Products are Safe Despite this Warning?

In 1986, California voters approved the Safe Drinking Water and Toxic Enforcement Act known as Proposition 65 or Prop 65. The purpose of Proposition 65 is to ensure that people are informed about exposure to chemicals known by the State of California to cause cancer, birth defects and/or other reproductive harm. A company with ten or more employees that operates within the State of California (or sells products in California) must comply with the requirements of Proposition 65. To comply, businesses are: (1) prohibited from knowingly discharging listed chemicals into sources of drinking water; and (2) required to provide a "clear and reasonable" warning before knowingly and intentionally exposing anyone to a listed chemical. Proposition 65 mandates that the Governor of California maintain and publish a list of chemicals that are known to cause cancer, birth defects and/or other reproductive harm. The [Prop 65 list](#), which must be updated annually, includes over 1,000 chemicals, including many that are commonly used in the electronics industry.

Although our manufacturing process is "lead-free" and RoHS compliant, it remains possible that trace amounts of lead could be found in components or subassemblies of Ambient Weather Products. Bisphenol A (BPSA) could conceivably be present in minute amounts in our plastic housings, lenses, labels, or adhesives, and DEHP & DINP (phthalates) could possibly be found in PVC wire coatings of our cables, housings, and power cords. Unlike RoHS, Prop 65 does not establish a specific threshold for reporting on the substances of concern and instead sets forth a much less definitive standard, requiring that the business demonstrate with certainty that there is "no significant risk" resulting from exposure. With respect to carcinogens, the "no significant risk" level is defined as the level which is calculated to result in not more than one excess case of cancer in 100,000 individuals exposed over a 70-year lifetime. In other words, if you are exposed to the chemical in question at this level every day for 70 years, theoretically, it will increase your chances of getting cancer by no more than 1 case in 100,000 individuals so exposed. With respect to reproductive toxicants, the "no significant risk" level is defined as the level of exposure which, even if multiplied by 1,000, will not produce birth defects or other reproductive harm. In other words, the level of exposure is below the "no observable effect level," divided by 1,000. (The "no observable effect level" is the highest dose level which has not been associated with observable reproductive harm in humans or test animals.) Proposition 65 does not clarify whether exposure is to be measured only in normal operation, or in the event of misuse such as intentionally damaging, incinerating or consuming an Ambient Weather Product or component, and Ambient Weather has not attempted to evaluate the level of exposure.

A Proposition 65 warning means one of two things: (1) the business has evaluated the exposure and has concluded that it exceeds the "no significant risk level;" or (2) the business has chosen to provide a warning simply based on its knowledge about the presence of a listed chemical without attempting to evaluate the exposure. The California government has itself clarified that "The fact that a product bears a Proposition 65 warning does not mean by itself that the product is unsafe." The government has also explained, "You could think of Proposition 65 more as a 'right to know' law than a pure product safety law."

**While using Ambient Weather Products as intended, we believe any potential exposure would be negligible or well within the "no significant risk" range. However, to ensure compliance with California law and our customers' right to know, we have elected to place the Proposition 65 warning signs on Ambient Weather Products.**

For further information about California's Proposition 65, please visit <https://oehha.ca.gov/prop65/background/p65plain.html>

