

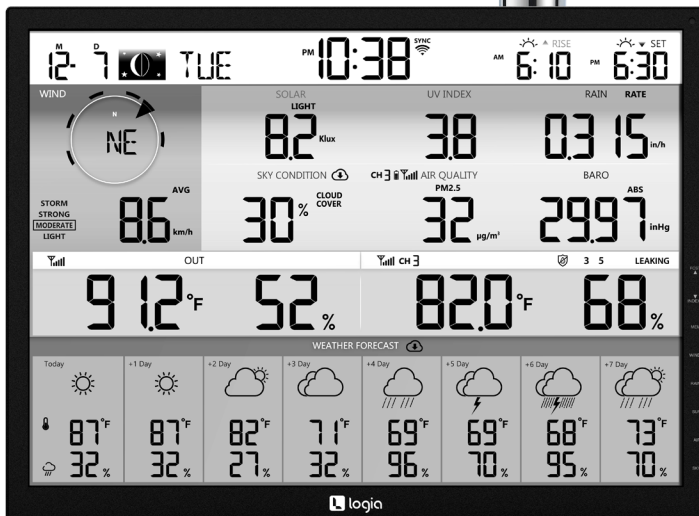

7-IN-1 WIRELESS 8-DAY FORECAST WEATHER STATION WITH WI-FI,[®] EVERLASTING SOLAR CELL, & ULTRA-WIDE DISPLAY USER GUIDE

LOWSC717FWB19



Thank you for purchasing the **Logia 7-in-1 Wireless 8-Day Forecast Weather Station with Wi-Fi,[®] Everlasting Solar Cell, and Ultra-Wide Display.** This User Guide is intended to provide you with guidelines to ensure that operation of this product is safe and does not pose risk to the user. Any use that does not conform to the guidelines described in this User Guide may void the limited warranty.

Please read all directions before using the product and retain this guide for reference. This product is intended for household use only. It is not intended for commercial use.

This product is covered by a limited one-year warranty. Coverage is subject to limits and exclusions. See warranty for details.

■ TABLE OF CONTENTS

SAFETY PRECAUTIONS	3
PRODUCT FEATURES	4
PACKAGE CONTENTS	5
WEATHER CONSOLE OVERVIEW	6
CONSOLE LCD DISPLAY OVERVIEW	7
WIRELESS SENSOR OVERVIEW	8
INSTALLATION INSTRUCTIONS	9
SETTING UP THE WIRELESS 7-IN-1 OUTDOOR SENSOR	9
SETTING UP THE DISPLAY CONSOLE	14
PAIRING THE CONSOLE WITH THE WIRELESS 7-IN-1 SENSOR	15
OPERATING INSTRUCTIONS/FORECAST	16
OUTDOOR TEMPERATURE, HUMIDITY & TEMPERATURE	17
INDOOR/CHANNELS TEMPERATURE & HUMIDITY	18
MULTI-CHANNEL AND SCROLL MODE FOR OPTIONAL SENSORS	19
WIND	20
BEAUFORT SCALE	22
BAROMETRIC PRESSURE/ RAIN/ LIGHT INTENSITY, UV INDEX & SUNBURN TIME	23
AIR QUALITY	24
MAX/MIN	25
MOON PHASE/ SUNRISE/SUNSET & MOON RISE/MOON SET TIME	26
WIRELESS SIGNAL RECEPTION/ TIME SYNCHRONIZE STATUS/ WI-FI [®] CONNECTION STATUS	27
TIME, DATE, AND GENERAL SETTINGS	28
CREATE PWL ACCOUNT & SET UP WI-FI [®] CONNECTION	29
SETTING UP WI-FI [®] CONNECTION	31
SETTING UP WEATHER SERVER CONNECTION	32
PROWEATHERLIVE (PWL) LIVE DATA	34
CARE AND MAINTENANCE	36
COMPATIBLE DEVICES	37
TROUBLESHOOTING	37
SPECIFICATIONS	38
LIMITED WARRANTY TO ORIGINAL CONSUMER	41

■ SAFETY PRECAUTIONS

WARNING! Please read and understand all safety precautions, operating instructions, and care/maintenance instructions before operating this appliance. Keep this manual for future reference.

- This product is not a toy. Keep out of the reach of children.
- This product is designed for use in the home only as indication of weather conditions. This product is not to be used for medical purposes or for public information.
- Do not clean the unit with abrasive or corrosive materials.
- Do not place the appliance near open flames or heat sources. Fire, electric shock, product damage, or injury might occur.
- Only use fresh, new batteries in the product. Do not mix new and old batteries together.
- Do not disassemble, alter, or modify the product.
- Only use attachments or accessories with this product specified by the manufacturer.
- Do not submerge the unit in water. Dry the product with a soft cloth if liquid spills on it.
- Do not subject the unit to excessive force, shock, duct, extreme temperature, or humidity.
- Do not cover or block the ventilation holes with any objects.
- This console of this product is intended to be used indoors only.
- This product is only suitable for mounting at height less than 6.6 ft. (2 m).
- Do not tamper with the unit's internal components. Tampering with the product will void the warranty.
- Batteries are not included. When inserting batteries, make sure that the positive and negative polarities match with the markings in the compartment.
- Do not mix standard, alkaline, and rechargeable batteries together.
- Leaving a battery exposed to extremely high temperature in the surrounding environment can result in an explosion or leakage of flammable liquid or gas.
- Leaving a battery exposed to extremely low air pressure in the surrounding environment can result in an explosion or leakage of flammable liquid or gas.

QUESTIONS OR PROBLEMS? CONTACT US!

Email: info@supportcbp.com or call: 1-833-815-0568
www.logiaweatherstation.com

■ PRODUCT FEATURES

1. Wireless 7-in-1 weather sensor measures wind speed, wind direction, rainfall, UV index, light intensity, temperature, and humidity
2. No calibration needed! The product is fully pre-calibrated and mostly assembled; all you need to do is install it and sync with the included display console
3. Provides precise weather and environmental information directly from your own backyard, instead of relying on a national weather station
4. Large, colorful LCD display with an 8-day forecast and dimmable backlight
5. Syncs via Wi-Fi® to an online weather server, ProWeatherLive

PACKAGE CONTENTS

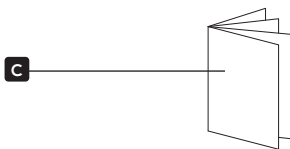
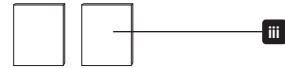
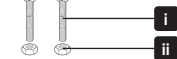
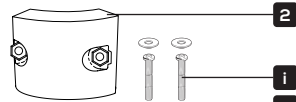
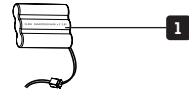
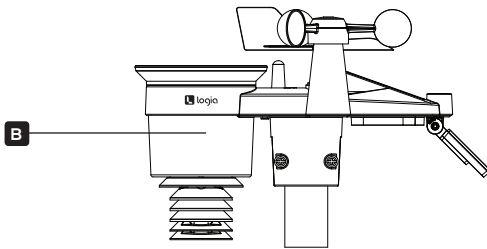
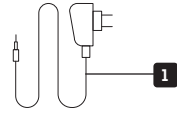
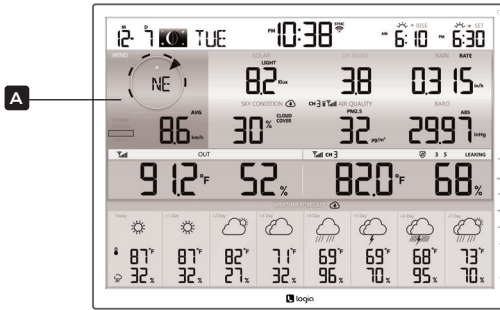

A. Weather display console

1. Console power adapter
2. Console CR2032 battery

B. 7-in-1 outdoor weather sensor

1. 3.6 V rechargeable battery pack
2. Mounting clamp
 - i. 2 x screws (for clamp)
 - ii. 2 x hexagonal nuts (for clamp)
 - iii. 2 x rubber pads (for clamp)

C. User guide

PRODUCT OVERVIEW

WEATHER CONSOLE OVERVIEW

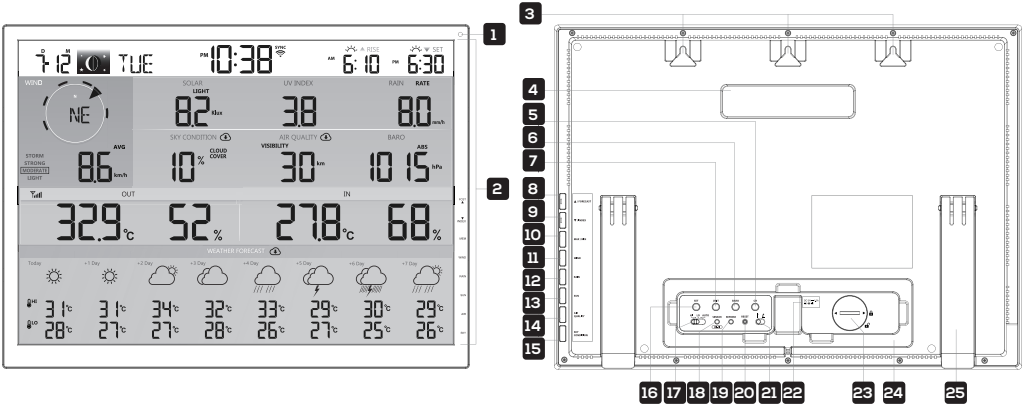

1. Ambient light detector
2. Display screen
3. Wall mounting holes
4. Carrying handle
5. CH button
6. BARO button
7. UNIT button
8. UP/FORECAST button
9. DOWN/INDEX button

10. MAX/MIN button
11. WIND button
12. RAIN button
13. SUN button
14. AIR QUALITY button
15. SKY CONDITION button
16. SET button
17. HI/LO/AUTO slider

18. SENSOR/WIFI button
19. REFRESH button
20. RESET button
21. Viewing angle slider
22. Power jack
23. Battery compartment
24. Cable slot
25. Built-in kickstand

LCD DISPLAY OVERVIEW

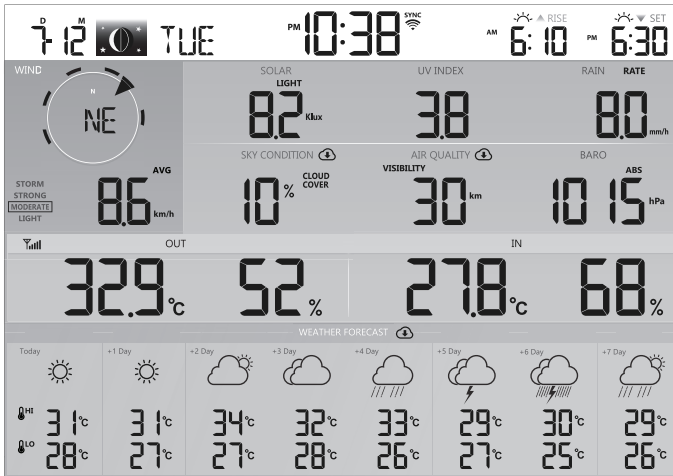

1			
2	3	4	5
	6	7	8
10		9	
11			

1. Time & date, moon phase, sunrise/sunset & moon rise/moon set
2. Wind direction & speed
3. Solar light intensity
4. UV index
5. Rainfall & rain rate
6. Sky condition
7. Air quality
8. Barometer
9. Indoor/CH temperature & humidity
10. Outdoor temperature & humidity
11. Today and 7-day weather forecast

WIRELESS SENSOR OVERVIEW

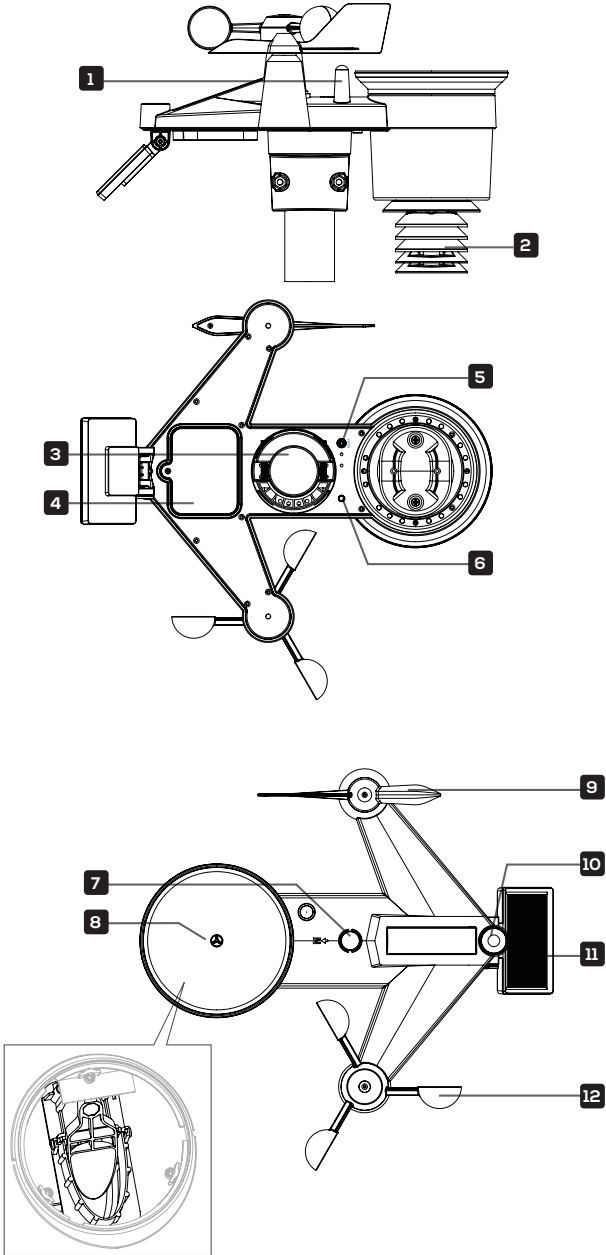

- | | | |
|---|----------------------------|---------------------|
| 1. Antenna | 5. RESET button | 9. Wind vane |
| 2. Radiation shield & hygro-thermo sensor | 6. Transmission status LED | 10. UV/light sensor |
| 3. Mounting base | 7. Bubble level | 11. Solar Cell |
| 4. Battery door | 8. Rain collector | 12. Wind cups |

■ INSTALLATION INSTRUCTIONS

SETTING UP THE WIRELESS 7-IN-1 OUTDOOR SENSOR

The wireless 7-in-1 outdoor sensor measures wind speed, wind direction, rainfall, UV, light intensity, temperature, and humidity.

INSTALLING THE RAIN FUNNEL

1. Align the lock grooves on the rain funnel with the lock grooves in the rain collector.
2. Lower the rain funnel onto the rain collector. Then, turn the rain funnel clockwise to lock it in place.

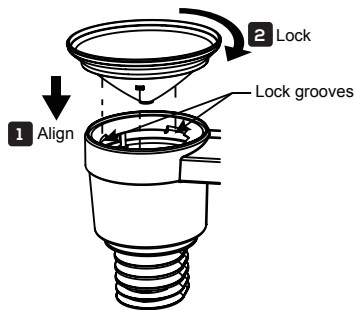

INSTALLING THE BATTERIES

1. Unscrew the battery door at the bottom of the 7-in-1 outdoor sensor using a screwdriver (not included).

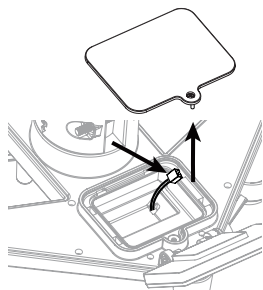

2. Connect the cable of the rechargeable battery pack (included) to the cable located in the battery compartment.

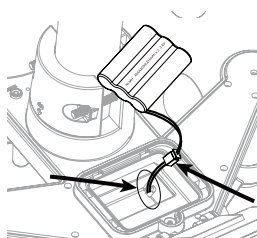

3. Adjust the connected cables so they fit comfortably in the compartment. Then, insert the battery pack into the compartment.

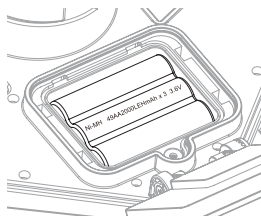

4. Close and fasten the battery door back on the compartment.

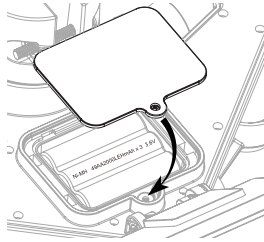

NOTE: The LED light will flash red every 12 seconds.

ADJUSTING THE SOLAR CELL

1. Remove the protection film on the solar cell.

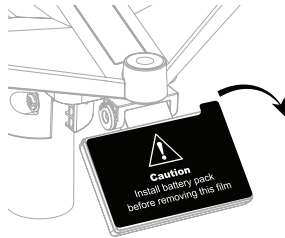

2. Loosen the screw at the joint so the gear on the other side of the joint pushes out. The solar cell should now be in an unlocked position.

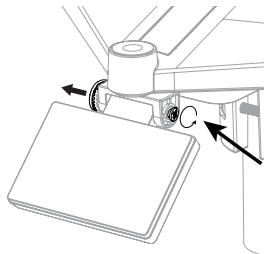

- Adjust the vertical angle of the solar cell to get the most optimal usage out of the solar cell depending on your location.

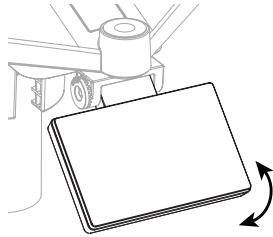

- Push the gear inward and tighten the screw until the gears lock in place.

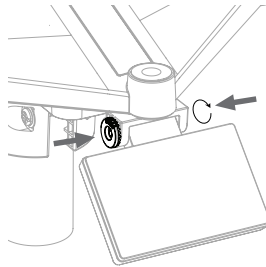

The joint of the solar cell is labeled with different degrees (0, 15, 30, 45, and 60). To place the solar cell in the right position for your location, set the solar cell to the angle that is closest to your latitude. View chart below to get an idea how you should angle your solar cell.

NOTE: The weather station cannot tell you what the latitude of your location is. You will have to research your latitude before you can properly adjust the solar cell.

Latitude Proximity	Solar Cell Angle Selection
If your location is close to 60°	60°
If your location is close to 45°	45°
If your location is close to 30°	30°
If your location is close to 15°	15°
If your location is close to 0°	0°

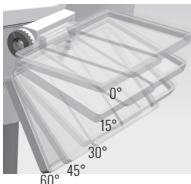
 A photograph of the solar cell joint showing five different angle markings: 0°, 15°, 30°, 45°, and 60°. The solar cell is shown at the 30° angle.

MOUNTING THE SENSOR ON A POLE

1. Stick the rubber pads on the inside of the mounting clamp and mounting base of the sensor.
2. Insert two (2) screws into the mounting base and clamp. Then, loosely tighten the screws using included nuts.
3. Place the mounting fixture over a pole (not included).
4. Tighten all the screws so the sensor sits firmly and securely on the pole.

NOTE: Place the mounting base and clamp on a steel pole or post with a 1.2" – 1.6" (30 – 40 mm) diameter and is a minimum of 6.6' (2 m) off the ground.

When setting up the outdoor sensor, make sure the rain collector side is facing north.

When placing the outdoor sensor, make sure it is within 492' (150 m) of the display console.

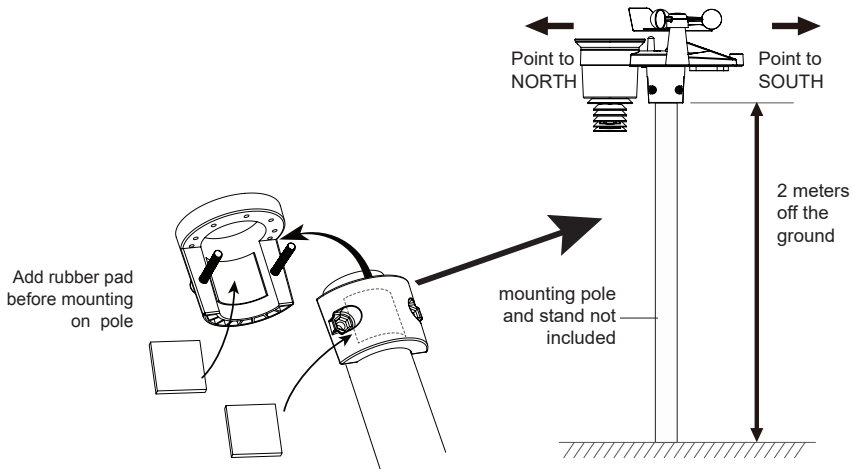

POINTING THE WIRELESS 7-IN-1 OUTDOOR SENSOR TO SOUTH (OPTIONAL)

The outdoor wireless weather sensor is calibrated to be pointed north for maximum accuracy. However, for your convenience, if you are a user located in the Southern Hemisphere, you can use the sensor with the wind vane pointing south.

1. Mount and install the wireless weather sensor with the wind meter end pointed South, instead of North. (Please refer to Mounting Sensor on Pole for mounting instructions.)
2. Select "S" in hemisphere section of the setup UI setup page. (Please refer to Setting Up Weather Server Connection section for setup details)
3. Press the APPLY icon to confirm and exit.

NOTES: Changing the hemisphere setting will automatically switch the direction of the moon phases on the display.

Pointing the wireless weather sensor toward the south will allow maximum sunlight on the solar panel, especially during the winter season in the Southern Hemisphere.

SETTING UP THE DISPLAY CONSOLE

INSTALLING THE BATTERIES

1. Remove the battery door on back of the console.
2. Insert a CR2032 battery (included) into the compartment.
3. Place the battery door back onto the compartment and twist it in place.

NOTES: If nothing appears on the display after inserting the battery, then press the RESET button using a pin.

Remove the battery if you plan to store the display console for a long period of time.

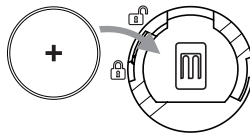

POWERING UP THE CONSOLE

1. Connect the power adapter to the integrated power cord of the console.
2. Plug the power adapter into a power outlet to turn on the console.
3. Once the console is turned on, the segments on the LCD display will light up.

NOTE: Once the console is powered on, the console will automatically enter AP mode and show the "AP" icon on the screen.

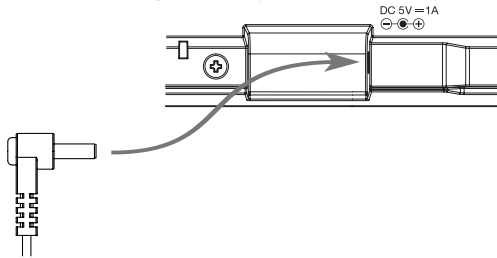

PAIRING THE CONSOLE WITH THE WIRELESS 7-IN-1 SENSOR

1. Once your display console powers on, it should automatically search for and connect to the wireless weather sensor. If the console does not connect within the first 15 minutes, press the SENSOR/WIFI button to manual pair the sensor and console.
2. Once the pairing process is complete, the antenna icon will appear solid (not blinking), and the readings for outdoor temperature, humidity, wind speed, wind direction, UV, light intensity, and rainfall will appear in their designated sections of the LCD display.

DATA CLEARING

1. Sensors within the 7-in-1 outdoor sensor may activate incorrectly during installation. Press the RESET button once to restart the console and clear all erroneous data.

OPERATING INSTRUCTIONS

FORECAST

Based on the longitude and latitude of the device in your ProWeatherLive (PWL) account, (refer to PWL section for setup), the console indicates the weather forecasts of today and next seven (7) days.

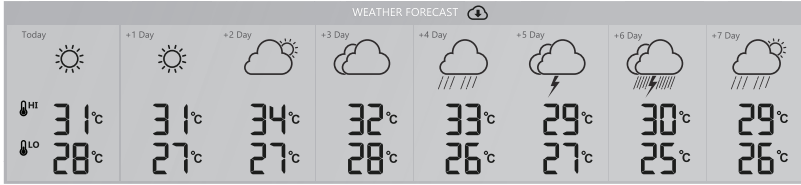

MULTI-DAY WEATHER FORECAST CHART

When you first power up the console, or press and hold the WI-FI/SENSOR button for six (6) seconds. Familiarize yourself with the 15 weather icons that can appear on the console according to weather forecast.

Sunny	Partly cloudy	Cloudy / Foggy	Overcast	Windy
Light rain	Heavy rain	Partly cloudy with light rain	Partly cloudy with heavy rain	Thunderstorm
Thunder showers	Stormy rain	Snowy	Snowy rain	Heavy Snowy rain

HIGH/LOW TEMPERATURE FORECAST FOR TODAY & NEXT 7 DAYS

Weather forecast with High (HI) and Low (LO) temperatures is default mode in this section, if updates are normal, the icon will appear and updated interval will occur per hour.

By default, the console shows the High (HI) and Low (LO) temperatures of the current day and next seven (7) days.



AVERAGE TEMPERATURE FORECAST WITH CHANCE OF RAIN FOR TODAY & NEXT 7 DAYS

The HI and LO temperatures can be displayed can be changed to display average temperature (AVG) and chance of rain of the current day to the next seven (7) days by pressing the UP/FORECAST button.

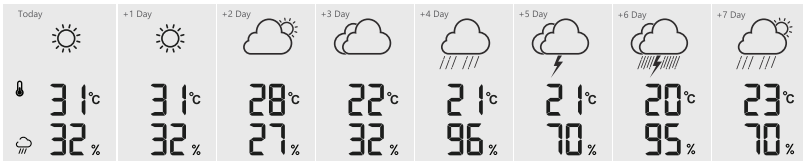

NOTE: If the Wi-Fi connectivity is not stable for over three (3) hours, the weather forecast, cloud cover, and visibility will not be shown, and the icon will disappear.

OUTDOOR TEMPERATURE, HUMIDITY & TEMPERATURE INDEX

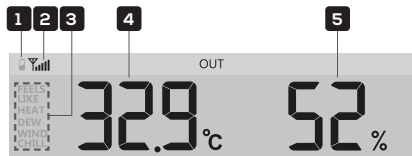

1. Outdoor sensor low battery indicator
2. Outdoor sensor signal indicator
3. Temperature index mode indicator
4. Outdoor temperature reading
5. Outdoor humidity reading

NOTES: If temperature/humidity is below the measurement range, the reading will show “Lo”. If temperature/humidity is above the measurement range, the reading will show “HI”.

Press DOWN/INDEX button to switch between Outdoor temperature, Feels Like, Heat Index, Wind Chill, and Dew Point.

FEELS LIKE

The Feels Like temperature index determines what the temperature feels like outside, taking into account factors like wind chill and the heat index.

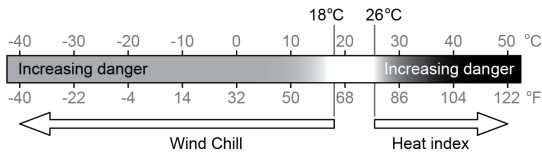

HEAT INDEX

The heat index is determined by the wireless weather sensor's temperature and humidity readings when the temperature is between 79 °F (26 °C) and 120 °F (50 °C).

Heat Index range	Warning	Explanation
81 °F – 90 °F (27 °C – 32 °C)	Caution	Possibility of heat exhaustion
91 °F – 104 °F (33 °C – 40 °C)	Extreme Caution	Possibility of heat dehydration
106 °F – 129 °F (41 °C – 54 °C)	Danger	Heat exhaustion highly likely
≥ 131 °F (≥ 55 °C)	Extreme Danger	Strong risk of dehydration/ heatstroke

WIND CHILL

Wind chill is determined by a combination of the wireless weather sensor's temperature and wind speed data.

DEW POINT

The dew point is the temperature below which the water vapor in air at constant barometric pressure condenses into liquid water at the same rate at which it evaporates. The condensed water is called dew when it forms on a solid surface.

The dew point temperature is determined by the temperature and humidity data from the wireless weather sensor.

■ INDOOR/CHANNEL TEMPERATURE & HUMIDITY

This section can show reading and status of the optional indoor hygro-thermo sensor(s) and water leak sensor(s).

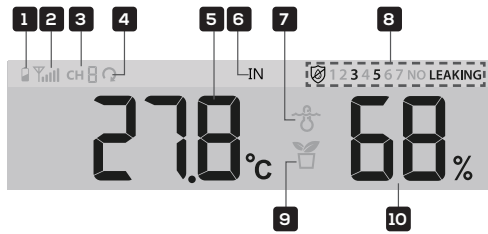

1. Low battery indicator for CH sensor
2. Sensor signal strength icon
3. Channel number icon
4. Auto loop icon
5. Temperature reading section
6. Indoor icon
7. Floating pool sensor icon
8. Water leak sensor status section
9. Soil moisture sensor icon
10. Humidity reading section

INDOOR TEMPERATURE & HUMIDITY

The indoor reading is the default mode of this console. This mode shows indoor temperature/humidity readings.

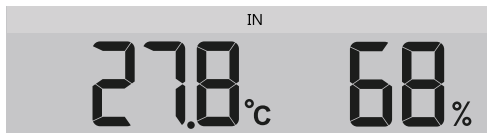

MULTI-CHANNEL AND SCROLL MODE FOR OPTIONAL SENSORS

Users can add up to seven (7) additional hydro-thermo sensors to display console. Press the CHANNEL button to switch between indoor and channels 1 to 7.



For auto-scroll function, just press and hold the CHANNEL button for three (3) seconds and the  icon will appear next to CH. The console will scroll the readings of all the sensors every three (3) seconds.

This mode shows current sensor's channel number, temperature/humidity, signal strength, and sensor type (pool or soil moisture sensor).

WATER LEAK SENSORS (OPTIONAL)

Users can add up to seven (7) additional water leak sensors to display console.

The channel number(s) of the corresponding water leak sensor(s) added to the console will be shown with the "NO LEAKING" icon.



When water leaking is detected, the channel number of the sensor detecting the leak and the "LEAKING" icon will flash together.



NOTE: When low battery is detected, the channel number of the sensor detecting the low battery condition will flash once every four (4) seconds.

WIND

Wind Speed and Direction Overview

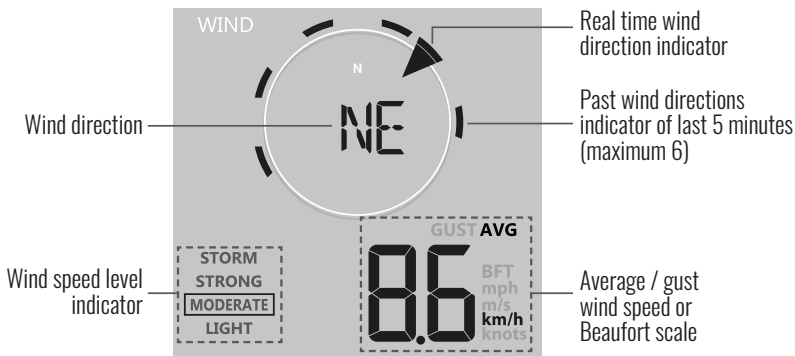

A solid arrow indicates the current real-time wind direction, whereas the bars indicate up to six (6) different wind direction of the past five (5) minutes.

Wind Speed, Gust, and Beaufort Scale Display

Press the WIND button to switch between the average wind speed measurement, gust wind speed measurement, and BFT measurement.

- AVERAGE: The AVERAGE wind speed will display the average of all wind speed numbers recorded in the previous 12 seconds.
- GUST: The GUST wind speed will display the highest wind speed recorded in the previous seconds.
- BFT: The Beaufort scale of current wind speed will be displayed.

The wind speed level chart on display provides a quick reference on the current wind condition.

Level	Light	Moderate	Strong	Storm
Speed	2-8 mph 3-13 km/h	9-25 mph 14-41 km/h	25-54 mph 42 - 57 km/h	≥ 55 mph ≥ 88 km/h

Wind Direction in 16-point directions and 360 Degrees

By default, wind direction is displayed by a 16-point compass, which include N, E, S, W, NE, NW, SE, SW, NNE, ENE, SSE, ESE, NNW, WNW, SSW, and WSW.

User can change wind direction to be shown in 360 degrees.

Press and hold WIND button for two (2) seconds until the wind direction is flashing. Press DOWN/INDEX or UP/FORECAST button to select the display format between 16-point direction and 360 degrees.

BEAUFORT SCALE

The Beaufort scale below is an international scale of wind velocities from 0 (calm) to 12 (Hurricane force).

Beaufort Scale	Description	Wind Speed	Land Condition
0	Calm	< 1 km/h	Calm. Smoke rises vertically.
		< 1 mph	
		< 1 knots	
		< 0.3 m/s	
1	Light air	1.1 - 5km/h	Smoke drift indicates wind direction. Leaves and wind vanes are stationary.
		1 - 3 mph	
		1 - 3 knots	
		0.3 - 1.5 m/s	
2	Light breeze	6 - 11 km/h	Wind felt on exposed skin. Leaves rustle. Wind vanes begin to move.
		4 - 7 mph	
		4 - 6 knots	
		1.6 - 3.3 m/s	
3	Gentle breeze	12 - 19 km/h	Leaves and small twigs constantly moving. Light flags extended.
		8 - 12 mph	
		7 - 10 knots	
		3.4 - 5.4 m/s	
4	Moderate breeze	20 - 28 km/h	Dust and loose paper raised. Small branches begin to move.
		13 - 17 mph	
		11 - 16 knots	
		5.5 - 7.9 m/s	
5	Fresh breeze	29 - 38 km/h	Branches of a moderate size move. Small trees in leaf begin to sway.
		18 - 24 mph	
		17 - 21 knots	
		8.0 - 10.7 m/s	
6	Strong breeze	39 - 49 km/h	Large branches in motion. Whistling heard in overhead wires. Umbrella use becomes difficult. Empty plastic bins tip over.
		25 - 30 mph	
		22 - 27 knots	
		10.8 - 13.8 m/s	
7	High wind	50 - 61 km/h	Whole trees in motion. Effort needed to walk against the wind.
		31 - 38 mph	
		28 - 33 knots	
		13.9 - 17.1 m/s	
8	Gale	62 - 74 km/h	Some twigs broken from trees. Cars veer on road. Progress on foot is seriously impeded
		39 - 46 mph	
		34 - 40 knots	
		17.2 - 20.7 m/s	
9	Strong gale	75 - 88 km/h	Some branches break off trees, and some small trees blow over. Construction / temporary signs and barricades blow over.
		47 - 54 mph	
		41 - 47 knots	
		20.8 - 24.4 m/s	
10	Storm	89 - 102 km/h	Trees are broken off or uprooted, structural damage likely.
		55 - 63 mph	
		48 - 55 knots	
		24.5 - 28.4 m/s	
11	Violent storm	103 - 117 km/h	Widespread vegetation and structural damage likely.
		64 - 73 mph	
		56 - 63 knots	
		28.5 - 32.6 m/s	
12	Hurricane force	≥ 118 km/h	Severe widespread damage to vegetation and structures. Debris and unsecured objects are hurled about.
		≥ 74 mph	
		≥ 64 knots	
		≥ 32.7 m/s	

BAROMETRIC PRESSURE

The atmospheric pressure is the pressure at any location of the earth caused by the weight of the column of air above it.

Absolute or Relative Barometric Pressure Mode

While in normal mode, press the BARO button to switch between ABSOLUTE and RELATIVE barometric pressure.

- ABS is absolute atmospheric pressure of your location.
- REL is relative atmospheric pressure based on the sea.



RAIN

Select the Rainfall Display Mode

Press the RAIN button to toggle between:

- RATE: current rainfall rate (based on 10 min. rain data)
- HOURLY: total rainfall in the past hour
- DAILY: total rainfall since midnight
- WEEKLY: total rainfall for the current week
- MONTHLY: total rainfall since the beginning of the current month
- TOTAL: total rainfall since the last reset

Period of rainfall

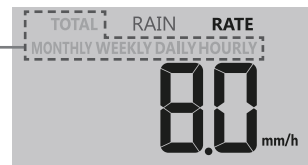

Reset the Rainfall Records

While in normal mode, press and hold the RAIN button for two (2) seconds to reset the rainfall records.

LIGHT INTENSITY, UV INDEX & SUNBURN TIME

Light Intensity & Sunburn Time Mode

During light intensity mode, press the SUN button to switch between sunlight intensity and sunburn time.



Solar light intensity mode



Sunburn time mode

UV Index VS Sunburn Time Chart

Exposure level	Low		Moderate			High		Very high			Extreme	
UV index	1	2	3	4	5	6	7	8	9	10	11	12-16
Sunburn time	N/A		45 minutes			30 minutes		15 minutes			10 minutes	
Recommended protection	N/A		Moderate or high UV level! Suggest to wear sunglasses, broad brim hat and long-sleeved clothing.					Very high or Extreme UV level! Suggest to wear sunglasses, broad brim hat and long-sleeved clothing. If you have to stay outdoors, make sure to seek shade.				

UV Index Mode

UV index shows the current UV index detected by the outdoor sensor.

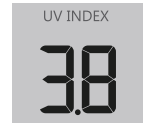

AIR QUALITY

This section shows the visibility distance according to the device's location inputted into ProWeatherLive (PWL). If you have optional PM2.5/PM10 air quality sensor(s), you can also view the corresponding data in this section.

Visibility Mode

Air visibility is measured in distance (either in kilometers or miles) and is generally refer to the distance at which an object or light can be clearly discerned, and it depends on the transparency of the surrounding air.

NOTE: If the Wi-Fi connectivity is not stable for over three (3) hours, the air visibility will not appear on the display and the  icon will disappear.



Additional PM2.5/PM10 Air Quality Sensors (Optional)

This console supports up to four (4) optional PM2.5/PM10 air quality sensors for you to detect different area's air quality. When you pair this sensor, you can press the AIR QUALITY button to check the readings in the following display sequence: Visibility > CH1 > CH2 > CH3 > CH4 PM2.5/PM10 sensor's reading.



Activate the Auto Loop for Air Quality

To activate the auto-loop function in this section, just press and hold the AIR QUALITY button for two (2) seconds and the  icon will show near the CH number and display the connected channels' reading at four (4) seconds interval.

Select the Air Quality Reading Unit

The PM2.5/PM10 sensor displays reading in PM2.5 by default. However, users can press the SET UNIT button to change readings in the following display sequence: PM2.5 > PM10 > PM2.5 AQI > PM10 AQI.

NOTE: The PM2.5/PM10 sensor is an optional sensor, which is not included

SKY CONDITION

The sky condition section shows the % of cloud cover according to the device's location inputted into PWL. If you have an optional lightning sensor, you can also view the lightning detection instantly.

Cloud cover mode

Cloud cover is an important component of understanding and predicting the weather.

NOTE: If the Wi-Fi connectivity is not stable for over three (3) hours, the cloud cover will not appear on the display and the ☁ icon will disappear.

Additional Lightning Sensor (Optional)

A wireless lightning sensor can be paired with this weather station console which would enables real-time viewing of lightning data on the display. When lightning strike is detected, red light will flash on the sensor. Press the SKY CONDITION button to view the following lightning information:

- Time since last lightning, and estimated lightning distance
- Number of lights per hour
- Return to Cloud Cover



Number of strikes in last hour



Last lightning time and estimated distance

Activate the Auto Loop for Sky Condition

To activate the auto-loop function in this section, just press and hold the AIR QUALITY button for two (2) seconds and the 🔄 icon will show near the CH number and display the connected channels' reading at four (4) seconds interval.

NOTE: The lightning sensor is an optional sensor, which is not included.

MAX/MIN

MAX/MIN Data Record

The display console can record the daily MAX/MIN weather data or MAX/MIN data since last reset.

MAX 10	MIN 10	MAX 5	MIN 5
Daily MAX reading	Daily MIN reading	MAX reading since last reset	MIN reading since last reset

To View the MAX/MIN

















While in normal operating mode, press the MAX/MIN button to cycle through the MAX/MIN records. Records are displayed in the following order:
Daily MAX records > daily MIN records > since MAX records > since MIN records

Reset the Total MAX/MIN Records

Press and hold the MAX/MIN button for two (2) seconds to reset the MAX/MIN records.

MOON PHASE

The sun-lit area of the moon moves from right to left in the Northern Hemisphere, while in the Southern Hemisphere, it moves from left to right. Below is the table which illustrate how the moon will appear on the console.

Northern Hemisphere Icons	Moon Phase	Southern Hemisphere Icons
	New Moon	
	Waxing Crescent Moon	
	First Quarter Moon	
	Waxing Gibbous Moon	
	Full Moon	
	Waning Gibbous Moon	
	Third Quarter Moon	
	Waning Crescent Moon	









SUNRISE/SUNSET & MOON RISE/MOON SET TIME

The console indicates your location's sunrise/sunset & moon rise/moon set times, which is based on time zone, latitude, and longitude of your device inputted into PWL.

Sunrise / sunset time	Moon rise / moon set time
 ▲ RISE AM 6:10 PM 6:30	 ▲ RISE PM 5:00 AM 5:30

WIRELESS SIGNAL RECEPTION

The display console shows signal strength for the following:

	No signal	Weak signal	Good signal
Outdoor 7-in-1 sensor			
Hygro-thermo sensor channel	CH 	CH 	CH 
Other optional sensor			

- If the sensor signal is lost and isn't recovered within 15 minutes, the signal icon will disappear. The temperature and humidity will display "Er" for the corresponding channel.
- If the sensor signal isn't recovered within 48 hours, the "Er" display will become permanent. If this happens, you need to replace the batteries and then press the SENSOR/WI-FI button to pair up the sensor again.

TIME SYNCHRONIZE STATUS

After the console has connected to the PWL, it can get the time according to your selected time zone in PWL. The "SYNC" icon will appear on the LCD with the time.



NOTE: The time will automatically synchronize per hour. User can also press the REFRESH button to get the internet time manually within one (1) minute.



WI-FI® CONNECTION STATUS

The "WI-FI" icon on the console indicates the console's connection status with your Wi-fi router.

- **Solid** – Console is currently connected to your router
- **Flashing** – Console is currently trying to connect to your router

	
Stable: Console is in connection with WI-FI router	Flashing: Console is trying to connect to WI-FI router

TIME, DATE, AND GENERAL SETTINGS

Press and hold the SET button for two (2) seconds to enter the setting mode. Press DOWN/INDEX or UP/FORECAST button to adjust the setting and press SET button again to save and proceed with next step of the setting. Refer to the chart below for the order of settings.

	Mode	Setting procedure
1	Hour	Press [√ / INDEX] or [^ / MODE] key to adjust the hour
2	Minute	Press [√ / INDEX] or [^ / MODE] key to adjust the minute
3	12/24 hour format	Press [√ / INDEX] or [^ / MODE] key to select 12 or 24 hour format
4	Year	Press [√ / INDEX] or [^ / MODE] key to adjust the year
5	Month	Press [√ / INDEX] or [^ / MODE] key to adjust the month
6	Day	Press [√ / INDEX] or [^ / MODE] key to adjust the day
7	M-D/D-M format	Press [√ / INDEX] or [^ / MODE] key to select "Month / Day" or "Day / Month" display format
8	Select Sunrise/ Sunset or Moon rise/ Moon set	Press [√ / INDEX] or [^ / MODE] key to select sunrise/sunset or moon rise/ moon set display format
9	Time sync ON/OFF	Press [√ / INDEX] or [^ / MODE] key to enable or disable Time Sync function. If you want to set the time manually, you should set Time Sync OFF
10	Weekday language	Press [√ / INDEX] or [^ / MODE] key to select weekday display language

NOTES: While in normal mode, press the SET button to switch between year and date display.

During these settings, you can go back to normal mode by press and hold the SET button for two (2) seconds.

UNIT SETTING

Use the UNIT button to change the unit of the readings on the console display.

1. Press and hold the UNIT button for two (2) seconds to enter the unit setting mode.
2. Press the UNIT button to proceed to the next setting step.
3. Press the UP/FORECAST or DOWN/INDEX button to change the value. Press and hold the button to change the value quickly.
4. Press and hold UNIT button for two (2) seconds to exit the unit setting mode at any time.

	Mode	Setting procedure
1	Temperature unit	Press [√ / INDEX] or [^ / MODE] key to select °C or °F
2	Rain unit	Press [√ / INDEX] or [^ / MODE] key to select mm or in
3	Wind speed unit	Press [√ / INDEX] or [^ / MODE] key to select m/s, km/h, knots or mph
4	Distance unit	Press [√ / INDEX] or [^ / MODE] key to select km or mi
5	Baro pressure unit	Press [√ / INDEX] or [^ / MODE] key to select hPa, inHg or mmHg
6	Light intensity	Press [√ / INDEX] or [^ / MODE] key to select Klux, Kfc or W/m ²

DISPLAY BACKLIGHT

The weather console backlight can be adjusted, using the HI/LO/AUTO slider to select the appropriate brightness:

- Slide to the HI position for the brighter backlight.
- Slide to the LO position for the dimmer backlight.
- Slide to the AUTO position for auto-adjusted backlight.

SET VIEWING ANGLE

Use the viewing angle slider to change the viewing angle of the display.

If the console is placed directly on a flat surface with the kickstand, move the slider to the table stand icon position, if the console is hung on the wall with the wall mounting hole, move the slider to wall mount icon position.

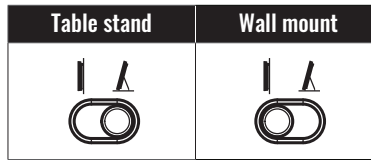

CREATE PWL ACCOUNT & SET UP WI-FI® CONNECTION

The console can upload/download weather data in ProWeatherLive (PWL) cloud server through wi-fi router, follow the step below to set up your device.

Create Your PWL Account

1. Visit the ProWeatherLive website at <https://www.proweatherlive.net> and click the “Create Your Account”. Follow the instructions to create an account.

NOTE: Please use a valid email address to register your account.

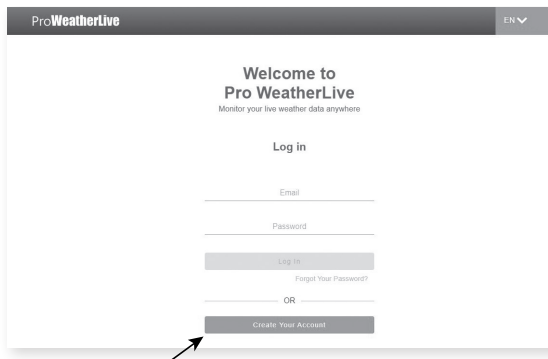

- Once your account is created, sign into it, and then click **“Edit Devices”** in the drop-down menu to add a new device.



- In **“Edit Devices”** page, click the **“+Add”** on the top right corner to create a new device, it will generate the station ID and key instantly, jot down both and then click **“FINISH”** to create the station tab.

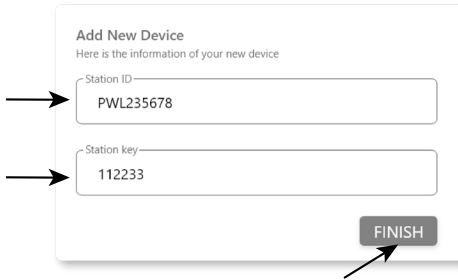

- Click the **“Edit”** on the top right corner of the station tab.

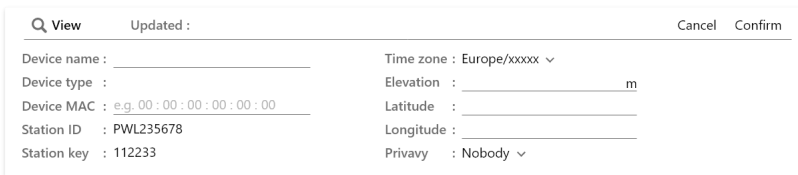

- Enter in the **“Device name”**, **“Device MAC address”**, **“Elevation”**, **“Latitude”**, **“Longitude”** and select your time zone in the station tab, then click **“Confirm”** to save the setting.



6. On the “Setup” page, enter the Station ID and key assigned by ProWeatherLive that you received.

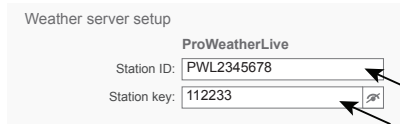

Weather server setup

ProWeatherLive

Station ID: PWL2345678

Station key: 112233

The form shows two input fields. The first field is labeled 'Station ID' and contains the text 'PWL2345678'. The second field is labeled 'Station key' and contains the text '112233'. There are two arrows pointing to the right side of the input fields, indicating where to click to save or proceed.

SETTING UP WI-FI® CONNECTION

When you first power up the console, the console LCD display will show the “AP” flashing and the  icon to signify that it has entered Access Point (AP) mode. The user can also press and hold the SENSOR/Wi-Fi button for six (6) seconds to enter AP mode manually. At this time, the console is ready for the Wi-Fi® settings to be adjusted.



Use your smartphone, tablet, or computer to connect to the console via Wi-Fi® by following these steps:

1. On PC, open your Wi-Fi® network settings. On Android™ or iOS devices, go to settings menu and then select Connections/WI-FI to open the network settings.
2. Locate the display console’s SSID from the list. It should appear as PWS-XXXXXX (where all the X’s are integers) in the list. Tap on the SSID to connect. This step will take several seconds.
3. Once you are connected to the display console, open your internet or mobile web browser, and enter the following address into the address bar: <http://192.168.1.1> (make sure to include the <http://> or else the web browser may interpret the address as a search query). We recommend using the latest version of reputable web browsers.

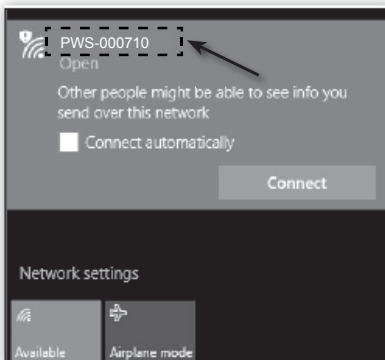

E.g. PC Wi-Fi network interface

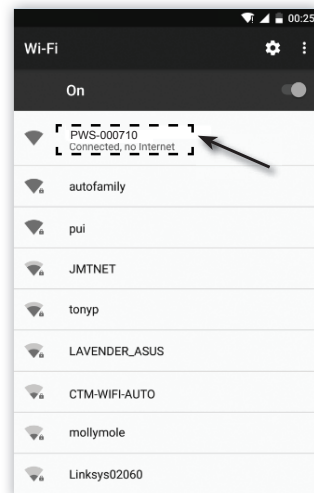

E.g. Android smart phone Wi-Fi network interface

SETTING UP WEATHER SERVER CONNECTION

Enter the information into the following web interface "SETUP" page. Ensure all information is entered prior to pressing **Apply** to connect the console to ProWeatherLive.

The screenshot shows the 'SETTINGS' page with a 'SETUP' tab selected. The 'ADVANCED' tab is also visible. The page is divided into several sections: 'WiFi Router setup', 'Weather server setup', 'Mac address', and 'Outdoor sensor direction'. At the bottom, the 'Firmware version' is displayed as 1.00, and an 'Apply' button is present.

Annotations:

- Press "ADVANCED" icon to advanced page:** Points to the 'ADVANCED' tab.
- Select setup UI display language:** Points to the 'Language: English' dropdown.
- Press to search router:** Points to the 'Search' button.
- Press to allow add router manually:** Points to the 'Add Router' button.
- Select router (SSID) for connection:** Points to the 'Router: ROUTER_A' dropdown.
- Manually enter the SSID if not on list:** Points to the empty text input field below the router dropdown.
- Select router's security type:** Points to the 'Security type: WAP2' dropdown.
- Router password (leave blank if the security type is "Open"):** Points to the 'Router Password' text input field.
- Enter station ID and key assigned by the ProWeatherLive (PWL):** Points to the 'Station ID: PWL2345678' text input field.
- Device Mac address:** Points to the 'Mac address: 00:0E:C6:00:07:10' text input field.
- Select the sensor located hemisphere (e.g. US and EU countries are "N" Australia is "S"):** Points to the 'Point to: N' dropdown.
- Current firmware version:** Points to the 'Firmware version: 1.00' text.
- Press to complete the WI-FI related setting:** Points to the 'Apply' button.

ADVANCE SETTING IN WEB INTERFACE

Press the "ADVANCED" button at the top of web interface to enter the advance setting page, this page allows you to set and view the calibration data of the console, as well as update the firmware version on PC/Mac web browser.

SETTINGS

SETUP **ADVANCED**

Press "SETUP" icon to setup page

Select setting unit

Temperature Humidity %

In/Outdoor & CH 1~7 temperature calibration section

Indoor	<input type="text"/>	Current offset: 0	<input type="text"/>	Current offset: 0
Outdoor	<input type="text"/>	Current offset: 0	<input type="text"/>	Current offset: 0
CH 1	<input type="text"/>	Current offset: 0	<input type="text"/>	Current offset: 0
CH 2	<input type="text"/>	Current offset: 0	<input type="text"/>	Current offset: 0
CH 3	<input type="text"/>	Current offset: 0	<input type="text"/>	Current offset: 0
CH 4	<input type="text"/>	Current offset: 0	<input type="text"/>	Current offset: 0
CH 5	<input type="text"/>	Current offset: 0	<input type="text"/>	Current offset: 0
CH 6	<input type="text"/>	Current offset: 0	<input type="text"/>	Current offset: 0
CH 7	<input type="text"/>	Current offset: 0	<input type="text"/>	Current offset: 0

In/Outdoor & CH 1~7 humidity calibration section

Range: -20.0 ~ 20.0°C
-36.0 ~ +36.0°F (Default: 0.0)

Range: -20 ~ 20%
(Default: 0.0)

Select setting unit

Pressure calibration section

Pressure

Absolute Pressure Offset: Current offset: 0 (Default: 0)

Relative Pressure Offset: Current offset: 0 (Default: 0)

Current offset value is the value that you set before to offset the pressure reading

Setting Range:
-560~ 560hpa / -16.54 ~ 16.54inHg / -420 ~ 420mmHg

The rain, wind speed, UV and light calibration use gain method. The wind direction is +/- 90 offset

*Rain gain:	<input type="text"/>	Current gain: 1.00 Range: 0.5 ~ 1.5(Default: 1.00)
*Wind speed gain:	<input type="text"/>	Current gain: 1.00 Range: 0.5 ~ 1.5(Default: 1.00)
*Wind direction:	<input type="text"/>	Current offset: +0° Range: -90 ~ 90(Default: 0°)
*UV gain:	<input type="text"/>	Current gain: 1.00 Range: 0.01 ~ 10(Default: 1.00)
*Light gain:	<input type="text"/>	Current gain: 1.00 Range: 0.01 ~ 10(Default: 1.00)
*PM2.5:	<input type="text"/>	Current offset: 0 Range: -99 ~ 99(Default: 0)
*PM10:	<input type="text"/>	Current offset: 0 Range: -99 ~ 99(Default: 0)

The PM2.5 and PM10 is +/-99 offset (PM2.5 /10 calibration setting is for optional sensor only)

* Depends on the model

Current firmware version

Firmware version: 1.00

Browse

Upload

The firmware update function only available in PC/Mac web browser

ADVANCED page

CALIBRATION

1. You may enter or change the offset and gain values for different measurement parameters, while viewing the current offset and gain values next to the corresponding boxes.
2. Once you have completed your calibrations, press the APPLY button on the SETUP tab.
3. The current offset value will update to show the value that you entered (instead of the default value). If you want to change the value, you can enter a new value in the box beside the number (as in step 1). To update the value, again, press APPLY in the SETUP tab.

NOTE: We do not recommend calibration of most values with the exception of Relative Pressure, which must be correctly calibrated to reflect your distance above sea level to account for

PROWEATHERLIVE (PWL) LIVE DATA

Once your device is connected, login into your ProWeatherLive account and see your device's live weather data on the dashboard.

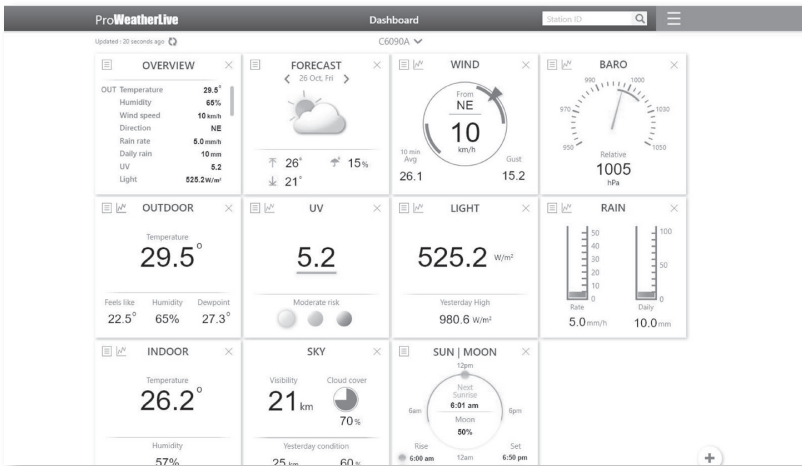

UPLOAD TO OTHER WEATHER SERVERS

The ProWeatherLive weather server allows data from each weather station to be uploaded to two (2) other weather servers such as WeatherUnderground, WeatherCloud, PWSWeather, or AWEKAS. For more information on setting up accounts for these servers, please refer to the HELP menu on ProWeatherLive.

FIRMWARE UPDATE

This display console supports OTA (over the air) Function Firmware and Wi-Fi System Firmware updates via any web browser (not mobile browser) on a PC that is connected to Wi-Fi®. The update function for both types of updates can be found at the bottom of the Advanced Tab on the wireless settings interface (see Advanced Settings via Web Interface).



Follow the steps below to update your device's Function or Wi-Fi® System Firmware

1. Download the latest version of the firmware (Function or Wi-Fi®) and save it to your PC. Remember where you saved the file.
2. Set the console into AP (access point) mode then connect the PC/Mac to the console (refer to Setting Up Wi-Fi® Connection).
3. On the SETUP page, press “Advanced” to enter advance setting.
4. Under the firmware upload section, press **Browse** to locate the firmware file saved on your PC/Mac.
5. Press **Upload** to start firmware update.
6. The console will restart once the update completes.
7. The console will stay in AP mode for you to check the firmware version and all the current setting. Simply press and hold SENSOR/WIFI button for six (6) seconds to exit AP mode.

NOTES: You cannot update the Function Firmware and Wi-Fi® Firmware at the same time. Updates must be installed one by one.

Make sure the power cable remains connected during the update process.

Make sure your PC's wireless connection is stable.

Once the update process starts, do not try to do anything else on your PC or on the display console.



CARE AND MAINTENANCE

BATTERY REPLACEMENT

If the low battery indicator icon  is displayed near the antenna icon of the sensor(s), this indicates that the batteries in your wireless weather sensor(s) are running low and should be replaced. Make sure to replace all batteries at the same time.

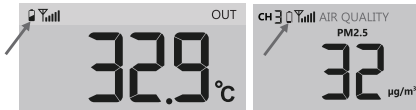

PAIRING THE SENSOR(S) MANUALLY

Whenever you changed the batteries of the 7-in-1 weather sensor or other additional sensors, re-synchronization must be done manually.

1. Change all the batteries to new ones in the low battery sensor(s).
2. Press the SENSOR/WIFI button on the console to enter sensor synchronization mode (as indicated by the flashing antenna).

FACTORY RESET

- To reset the console and start again, press the RESET button once or remove the backup battery and then unplug the adapter.
- To revert back to factory settings and remove all data, press and hold the RESET button for six (6) seconds.

WIRELESS OUTDOOR WEATHER SENSOR MAINTENANCE

Cleaning the Rain Funnel

1. Unscrew the rain funnel by turning the rain funnel counterclockwise.
2. Gently remove the rain funnel.
3. Clean and remove any debris or insects from the rain funnel.
4. Install the rain funnel when it is clean and fully dried.

Cleaning the Hygro-thermo Sensor

1. Remove the two (2) screws at the bottom of the radiation shield.
2. Gently remove the shield.
3. Carefully remove any dirt or insects on the sensor (do not let the sensors inside get wet).
4. Clean the shield with water to remove any dirt or insects.
5. Install all the parts back when they are clean and fully dried.

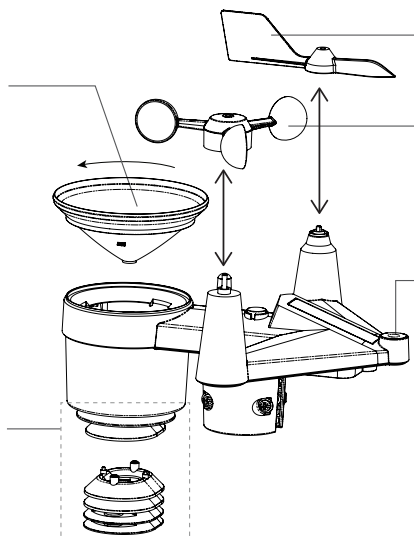

Replacing the Wind Vane

1. Unscrew and remove the wind vane for the new replacement.

Replacing the Wind Cup

1. Remove the rubber cup and unscrew the wind cups.
2. Remove the wind cups for the new replacement.

Cleaning the UV Sensor and Calibration

- For precision UV measurement, gently clean the UV sensor cover lens with damp micro-fiber cloth.
- Over time, the UV sensor will naturally degrade. The UV sensor can be calibrated with a utility grade UV meter.

COMPATIBLE DEVICES

The display console of the Logia 7-in-1 Wireless Weather Station with Wi-fi[®], Everlasting Solar Cell, and 7" Full-Color HD LCD Display can be paired with other add-on sensors like the indoor hygro-thermo and soil moisture & temperature, and lightning add-on sensor.

Visit www.logiaweatherstations.com for the most updated list of compatible Logia add-on sensors.

TROUBLESHOOTING

PROBLEM	SOLUTION
7-in-1 wireless sensor is not connecting.	<ol style="list-style-type: none">1. Make sure the sensor is within the transmission range.2. If it still does not work, reset the sensor, and resynchronize with console.
Additional wireless sensor(s) are not connecting.	<ol style="list-style-type: none">1. Make sure the sensor(s) is/are within the transmission range.2. Make sure the channel displayed matches the channel selection on sensor.3. If it still does not work, reset the sensor and resynchronize with console.
No Wi-fi connection	<ol style="list-style-type: none">1. Check the WI-FI icon on the display, it should be on if connectivity is successful.2. In the console SETUP page, make sure the WI-FI settings (router's name, security type and password) are correct.3. Make sure you connect to 2.4G band of the WI-FI router (5G not supported).
Data isn't transferring to ProWeatherLive.	<ol style="list-style-type: none">1. In the console SETUP page, ensure your Station ID and Station Key are correct.2. In the "Edit Devices" of the console on PWL, ensure the device's Mac address is entered correctly.
Multi-day forecast, cloud cover, visibility, sunrise/sunset, moon rise/moon set times are not accurate.	<ol style="list-style-type: none">1. Ensure your console is connected to PWL.2. Ensure latitude, longitude & time zone in "Edit Devices" of the console on PWL are correct.3. Press the REFRESH button to update the data instantly.
Sunrise/sunset, moon rise/moon set times are different to that of PWL.	<ol style="list-style-type: none">1. Ensure your console is connected to PWL.2. Ensure the console Time Sync is set to ON.
Rainfall data is not correct.	<ol style="list-style-type: none">1. Make sure the rain collector is clean for the tipping bucket to tip smoothly.2. Make sure the sensor has stable and level to ensure correct tipping.
Temperature is too high in the daytime.	<ol style="list-style-type: none">1. Place the sensor in open area and at least 4.9' (1.5 m) off the ground.2. Ensure that the sensor is placed away from heat generating sources or structures, such as buildings, pavement, walls, or air conditioning units.
Some condensation beneath the UV sensor may occur overnight.	This will disappear when temperature rises up under the sun and will not affect the performance of the unit.

■ SPECIFICATIONS

DISPLAY CONSOLE	
General Specifications	
Product type	Weather/environment sensor & console
Dimensions (W x H x D)	16.5" x 12.1" x 1.2" (419 x 308 x 30 mm)
Weight	4.5 lbs. (2034 g) (with battery)
Power source	DC 5 V, 1.5 A adapter
Backup battery	CR2032
Operating temperature environment	23 °F ~ 122 °F (-5 °C ~ 50 °C)
Adult assembly required for console	No
Location use for console	Indoor use
Additional tools required for console	No
Country of origin	China
Warranty included	Yes
Warranty length	1 year
Wi-Fi® Communication Specifications	
Wi-Fi standard	802.11 b/g/n
Wi-Fi operating frequency	2.4 GHz
Supported router security type	WPA/WPA2, WPA3, OPEN, WEP (WEP only support Hexadecimal password)
Supported devices for setup UI	Built-in wi-fi with AP mode function smart devices or laptops e.g.: Android smartphone, Android pad, iPhone, iPad, or PC/Mac computer
Recommended web browser for setup UI	Web browsers that support HTML 5
Website	https://proweatherlive.net
App name	ProWeatherLive
Supported sensors	<ul style="list-style-type: none"> • 1 wireless 7-in-1 weather outdoor sensor • Up to 7 wireless hygro-thermo sensors/soil moisture sensor/pool sensor (optional) • Up to 7 wireless water leak sensors (optional) • Up to 4 wireless PM2.5/PM10 air quality sensors (optional) • 1 wireless lightning sensor (optional)
RF frequency	915 MHz (US version)
RF transmission range	492' (150 m)
Time-related Function Specifications	
Time display	HH:MM
Hour format	12 hr. AM/PM or 24 hr.
Date display	DD/MM or MM/DD
Time synchronize method	Time received through PWL
Weekday languages	EN/DE/FR/ES/IT/NL/RU

Barometer Display & Function Specifications	
Note: The following details are listed as they are displayed or operate on the console.	
Barometer units	hPa, inHg, and mmHg
Measuring range	540 - 1100 hPa
Accuracy	(700 ~ 1100 hPa \pm 5 hPa) / (540 ~ 696 hPa \pm 8 hPa) (20.67 ~ 32.48 inHg \pm 0.15 inHg) / (15.95 ~ 20.55 inHg \pm 0.24 inHg) (525 ~ 825 mmHg \pm 3.8 mmHg) / (405 ~ 522 mmHg \pm 6 mmHg) Typical at 77°F (25°C)
Resolution	1 hPa / 0.01 inHg / 0.1 mmHg
Memory modes	Historical data for last 24 hours, daily Max / Min
Indoor Temperature Display & Function Specifications	
Note: The following details are listed as they are displayed or operate on the console.	
Temperature unit	°C and °F
Accuracy	< 32 °F or > 104 °F \pm 3.6 °F (< 0 °C or > 40 °C \pm 2 °C) 32 °F - 104 °F \pm 1.8 °F (0 °C - 40 °C \pm 1 °C)
Resolution	0.1 °F / 0.1 °C
Indoor Humidity Display & Function Specifications	
Note: The following details are listed as they are displayed or operate on the console.	
Humidity unit	%
Accuracy	1% ~ 20% RH \pm 6.5% RH @ 77 °F (25 °C) 21% ~ 80% RH \pm 3.5% RH @ 77 °F (25 °C) 81% ~ 99% RH \pm 6.5% RH @ 77 °F (25 °C)
Resolution	1%
Memory modes	Historical data of past 24 hours, daily Max / Min
WIRELESS 7-IN-1 OUTDOOR SENSOR	
General Specifications	
Product type	Weather/environment sensor
Dimensions (W x H x D)	12.7" x 11.7" x 8.5" (322 x 296 x 217 mm)
Weight	1.5 lbs. (705 g) (with battery pack)
Main power	3.6 V Ni-MH rechargeable battery pack
Weather data	Temperature, humidity, wind speed, wind direction, rainfall, UV, light intensity
RF transmission range	Up to 492' (150 m)
RF frequency	915 MHz
Transmission interval	Every 12 seconds UV, light intensity, wind speed, and wind direction data Every 24 seconds for temperature, humidity, and rain data
Operating temperature range	-40 °F ~140 °F (-40 °C ~ 60 °C)
Operating humidity range	1 ~ 99% RH
Location use for sensor	Outdoor use
Adult assembly required for sensor	Yes
Additional tools required for sensor	Screwdriver

Outdoor Temperature Display & Function Specifications	
Temperature unit	°C or °F
Weather index mode	Feels like, wind chill, heat index, and dew point
Feels like display range	-85 °F ~ 122 °F (-65 °C ~ 50 °C)
Dew point display range	-4 °F ~ 176 °F (-20 °C ~ 80 °C)
Heat index range	78.8 °F ~ 122 °F (26 °C ~ 50 °C)
Wind chill display range	-85 °F ~ 64.4 °F (-65 °C ~ 18 °C)
Resolution	0.1 °F/0.1 °C
Accuracy	41.2 °F ~ 140 °F ± 0.7 °F (5.1 °C ~ 60 °C ± 0.4 °C) -3.8 °F ~ 41 °F ± 1.8 °F (-19.9 °C ~ 5 °C ± 1 °C) -40 °F ~ -4 °F ± 2.7 °F (-40 °C ~ -20 °C ± 1.5 °C)
Outdoor Humidity Display & Function Specifications	
Note: The following details are listed as they are displayed or operate on the console.	
Humidity unit	%
Accuracy	1% ~ 20% RH ± 6.5% RH @ 77 °F (25 °C) 21% ~ 80% RH ± 3.5% RH @ 77 °F (25 °C) 81% ~ 99% RH ± 6.5% RH @ 77 °F (25 °C)
Resolution	1%
Wind Speed/Direction Display & Function Specifications	
Note: The following details are listed as they are displayed or operate on the console.	
Wind speed unit	mph, m/s, km/h, knots
Wind speed display range	0 ~ 112 mph, 50 m/s, 180 km/h, 97 knots
Resolution	0.1 mph, 0.1 m/s, 0.1 km/h, 0.1 knots
Speed accuracy	< 5 m/s: +/- 0.5 m/s; > 5 m/s: +/- 6%
Display mode	Gust/average
Wind direction	16 directions or 360 degrees
Rain Display & Function Specifications	
Rainfall unit	mm and in
Rain rate unit	mm/h and in/h
Accuracy for rainfall	± 7% or 1 tip
Range for rainfall	0 ~ 787.3 in (0 ~ 19999 mm)
Resolution	0.01 in (0.254 mm)
Rain display mode	Rate/hourly/daily/weekly/monthly/total rainfall
UV Index Display and Function Specifications	
Display range	0 ~ 16
Resolution	0.1
Light Intensity Display and Function Specifications	
Light intensity unit	Klux, Kfc, W/m ²
Display range	0 ~ 200 Klux
Resolution	0.01 Klux, 0.01 Kfc, and 0.01 W/m ²

LIMITED WARRANTY TO ORIGINAL CONSUMER

This **Logia 7-in-1 Wireless 8-Day Forecast Weather Station with Wi-fi,[®] Everlasting Solar Cell, and Ultra-Wide Display (“Product”)**, including any accessories included in the original packaging, as supplied and distributed new by an authorized retailer is warranted by **C&A Marketing, Inc. (the “Company”)** to the original consumer purchaser only, against certain defects in material and workmanship (**“Warranty”**) as follows:

To receive Warranty service, the original consumer purchaser must contact the Company or its authorized service provider for problem determination and service procedures. Proof of purchase in the form of a bill of sale or receipted invoice, evidencing that the Product is within the applicable Warranty period(s), **MUST** be presented to the Company or its authorized service provider in order to obtain the requested service.

Service options, parts availability, and response times may vary and may change at any time. In accordance with applicable law, the Company may require that you furnish additional documents and/or comply with registration requirements before receiving warranty service. Please contact our customer service for details on obtaining warranty service:

Email: info@supportcbp.com

Phone: 833-815-0568

Shipping expenses to the Company’s Return Facility are not covered by this warranty, and must be paid by the consumer. The consumer likewise bears all risk of loss or further damage to the Product until delivery to said facility.

EXCLUSIONS AND LIMITATIONS The Company warrants the Product against defects in materials and workmanship under normal use for a period of **ONE (1) YEAR** from the date of retail purchase by the original end-user purchaser (**“Warranty Period”**). If a hardware defect arises and a valid claim is received within the Warranty Period, the Company, at its sole option and to the extent permitted by law, will either (1) repair the Product defect at no charge, using new or refurbished replacement parts, (2) exchange the Product with a Product that is new or which has been manufactured from new or serviceable used parts and is at least functionally equivalent to the original device, or (3) refund the purchase price of the Product.

A replacement Product or part thereof shall enjoy the warranty of the original Product for the remainder of the Warranty Period, or ninety (90) days from the date of replacement or repair, whichever provides you longer protection. When a Product or part is exchanged, any replacement item becomes your property, while the replaced item becomes the Company’s property. Refunds can only be given if the original Product is returned.

This Warranty does not apply to:

- (a) Any non-Logia 7-in-1 Wireless 8-Day Forecast Weather Station with Wi-fi,[®] Everlasting Solar Cell, and Ultra-Wide Display product, hardware or software, even if packaged or sold with the Product;
- (b) Damage caused by use with non-Logia 7-in-1 Wireless 8-Day Forecast Weather Station with Wi-fi,[®] Everlasting Solar Cell, and Ultra-Wide Display products;
- (c) Damage caused by accident, abuse, misuse, flood, fire, earthquake, or other external causes;
- (d) Damage caused by operating the Product outside the permitted or intended uses described by the Company;
- (e) Damage caused by third party services;
- (f) A Product or part that has been modified to alter functionality or capability without the written permission of the Company;
- (g) Consumable parts, such as batteries, fuses and bulbs;
- (h) Cosmetic damage; or
- (i) If any Logia 7-in-1 Wireless 8-Day Forecast Weather Station with Wi-fi,[®] Everlasting Solar Cell, and Ultra-Wide Display serial number has been removed or defaced.

This Warranty is valid only in the country where the consumer purchased the Product, and only applies to Products purchased and serviced in that country.

The Company does not warrant that the operation of the Product will be uninterrupted or error-free. The Company is not responsible for damage arising from your failure to follow instructions relating to its use.

NOTWITHSTANDING ANYTHING TO THE CONTRARY AND TO THE MAXIMUM EXTENT PERMITTED BY APPLICABLE LAW, THE COMPANY PROVIDES THE PRODUCT "AS-IS" AND "AS-AVAILABLE" FOR YOUR CONVENIENCE AND THE COMPANY AND ITS LICENSORS AND SUPPLIERS EXPRESSLY DISCLAIM ALL WARRANTIES AND CONDITIONS, WHETHER EXPRESSED, IMPLIED, OR STATUTORY, INCLUDING THE WARRANTIES OF MERCHANTABILITY, FITNESS FOR A PARTICULAR PURPOSE, TITLE, QUIET ENJOYMENT, ACCURACY, AND NON-INFRINGEMENT OF THIRD-PARTY RIGHTS. THE COMPANY DOES NOT GUARANTEE ANY SPECIFIC RESULTS FROM THE USE OF THE PRODUCT, OR THAT THE COMPANY WILL CONTINUE TO OFFER OR MAKE AVAILABLE THE PRODUCT FOR ANY PARTICULAR LENGTH OF TIME. THE COMPANY FURTHER DISCLAIMS ALL WARRANTIES AFTER THE EXPRESS WARRANTY PERIOD STATED ABOVE.

YOU USE THE PRODUCT AT YOUR OWN DISCRETION AND RISK. YOU WILL BE SOLELY RESPONSIBLE FOR (AND THE COMPANY DISCLAIMS) ANY AND ALL LOSS, LIABILITY, OR DAMAGES RESULTING FROM YOUR USE OF THE PRODUCT.

NO ADVICE OR INFORMATION, WHETHER ORAL OR WRITTEN, OBTAINED BY YOU FROM THE COMPANY OR THROUGH ITS AUTHORIZED SERVICE PROVIDERS SHALL CREATE ANY WARRANTY.

IN NO EVENT WILL THE COMPANY'S TOTAL CUMULATIVE LIABILITY ARISING FROM OR RELATED TO THE PRODUCT, WHETHER IN CONTRACT OR TORT OR OTHERWISE EXCEED THE FEES ACTUALLY PAID BY YOU TO THE COMPANY OR ANY OF ITS AUTHORIZED RESELLERS FOR THE PRODUCT AT ISSUE IN THE LAST YEAR FROM YOUR PURCHASE. THIS LIMITATION IS CUMULATIVE AND WILL NOT BE INCREASED BY THE EXISTENCE OF MORE THAN ONE INCIDENT OR CLAIM. THE COMPANY DISCLAIMS ALL LIABILITY OF ANY KIND OF ITS LICENSORS AND SUPPLIERS. IN NO EVENT WILL THE COMPANY OR ITS LICENSORS, MANUFACTURERS AND SUPPLIERS BE LIABLE FOR ANY INCIDENTAL, DIRECT, INDIRECT, SPECIAL, PUNITIVE OR CONSEQUENTIAL DAMAGES (SUCH AS, BUT NOT LIMITED TO, DAMAGES FOR LOSS OF PROFITS, BUSINESS, SAVINGS, DATA OR RECORDS) CAUSED BY THE USE, MISUSE OR INABILITY TO USE THE PRODUCT.

Nothing in these terms shall attempt to exclude liability that cannot be excluded under applicable law. Some countries, states or provinces do not allow the exclusion or limitation of incidental or consequential damages or allow limitations on warranties, so certain limitations or exclusions may not apply to you. This warranty gives you specific legal rights, and you may have other rights that vary from state to state or province to province. Contact your authorized retailer to determine if another warranty applies.

FCC STATEMENT

This device complies with Part 15 of the FCC Rules. Operation is subject to the following two conditions:

(1) This device may not cause harmful interference, and;

(2) This device must accept any interference received, including interference that may cause undesired operation.

NOTE: This equipment has been tested and found to comply with the limits for a Class B digital device, pursuant to part 15 of the FCC Rules. These limits are designed to provide reasonable protection against harmful interference in a residential installation. This equipment generates—and can radiate—radio frequency energy and, if not installed and used in accordance with the instructions, may cause harmful interference to radio communications. However, there is no guarantee that interference will not occur in a particular installation. If the equipment does not cause harmful interference to radio or television reception, which can be determined by turning the equipment off and on, the user is encouraged to try to correct the interference by one or more of the following measures:

- Reorient or relocate the receiving antenna
- Increase the separation between the equipment and the receiver
- Connect the equipment into an outlet on a circuit different from that to which the receiver is connected.
- Consult the dealer or an experienced radio/TV technician for help.

The provided shielded USB cable must be used with this unit to ensure compliance with the class B FCC limits.

Warning: Changes or modifications to this unit not expressly approved by the party responsible for compliance could void the user's authority to operate the equipment.

If you experience any issues with your Logia 7-in-1 Wireless 8-Day Forecast Weather Station with Wi-fi® Everlasting Solar Cell, and Ultra-Wide Display, please contact us before returning your product to the place of purchase. We're here to help!

QUESTIONS OR PROBLEMS? CONTACT US!

Email: info@supportcbp.com or call: 1-833-815-0568

www.logiaweatherstation.com



LOGIA is a trademark of C&A IP Holdings LLC in the US, Canada, China, and the EU.

Android and Google Play are trademarks of Google LLC.

Apple, iOS, and App Store are trademarks of Apple Inc. in the U.S. and other countries.

Microsoft, Windows, Windows Server, Windows Vista, and Windows 10 are trademarks of Microsoft Corporation in the U.S. and/or other countries.

Wi-Fi, WPA, and WPA2 are trademarks of Wi-Fi Alliance in the U.S. and/or other countries.

All other products, brand names, company names, and logos are trademarks of their respective owners, used merely to identify their respective products, and are not meant to connote any sponsorship, endorsement, or approval.

Distributed by C&A Marketing, Inc., 114 Tived Lane East, Edison, NJ 08837. Made in China.

© 2022. C&A IP Holdings LLC. All Rights Reserved.