



**3-IN-1 RAIN SENSOR
AND LCD DISPLAY WITH
BUILT-IN HYGRO-THERMO
SENSOR
USER GUIDE**

LOWSB315B



Thank you for purchasing the **Logia 3-in-1 Rain Sensor and LCD Display with Built-In Hygro-Thermo Sensor**. This User Guide is intended to provide you with guidelines to ensure that operation of this product is safe and does not pose risk to the user. Any use that does not conform to the guidelines described in this User Guide may void the limited warranty.

Please read all directions before using the product and retain this guide for reference. This product is intended for household use only. It is not intended for commercial use.

This product is covered by a limited one-year warranty. Coverage is subject to limits and exclusions. See warranty for details.

■ TABLE OF CONTENTS

SAFETY PRECAUTIONS	3
PRODUCT FEATURES.....	4
PACKAGE CONTENTS.....	4
PRODUCT OVERVIEW	5 – 8
INSTALLATION INSTRUCTIONS.....	9 – 10
OPERATING INSTRUCTIONS.....	11 – 15
CARE/MAINTENANCE	16
TROUBLESHOOTING.....	16
SPECIFICATIONS.....	17 – 18
WARRANTY	19 – 20

■ SAFETY PRECAUTIONS

WARNING! Please read and understand all safety precautions, operating instructions, and care/maintenance instructions before operating this appliance. Keep this manual for future reference.

- This product is not a toy. Keep out of the reach of children.
- This product is designed for use in the home only as an indication of weather conditions. This product is not to be used for medical purposes or for public information.
- Do not clean the unit with abrasive or corrosive materials.
- Do not place the appliance near open flames or heat sources. Fire, electric shock, product damage, or injury might occur.
- Only use fresh, new batteries in the product. Do not mix new and old batteries together.
- Do not disassemble, alter, or modify the product.
- Only use attachments or accessories with this product specified by the manufacturer.
- Do not submerge the unit in water. Dry the product with a soft cloth if liquid spills on it.
- Do not subject the unit to excessive force, shock, duct, extreme temperature, or humidity.
- Do not cover or block the ventilation holes with any objects.
- This console of this product is intended to be used indoors only.
- This product is only suitable for mounting at a height less than 6.6 ft. (2 m).
- Do not tamper with the unit's internal components. Tampering with the product will void the warranty.
- Batteries are not included. When inserting batteries, make sure that the positive and negative polarities match with the markings in the compartment.
- Do not mix standard, alkaline, and rechargeable batteries together.
- Leaving a battery exposed to extremely high temperature in the surrounding environment can result in an explosion or leakage of flammable liquid or gas.
- Leaving a battery exposed to extremely low air pressure in the surrounding environment can result in an explosion or leakage of flammable liquid or gas.

QUESTIONS OR PROBLEMS? CONTACT US!

Email: info@supportcbp.com or call: 1-833-815-0568

www.logiaweatherstation.com

PRODUCT FEATURES

- Wireless 3-in-1 rain sensor measures rainfall and outdoor temperature.
- Console measures indoor temperature and humidity with built-in sensors.
- No calibration needed! The product is fully pre-calibrated and mostly assembled; all you need to do is install it and sync with the included display console.
- Provides precise weather and environmental information directly from your own backyard, instead of relying on a national weather station.
- Large LCD display with backlight and kickstand
- Real-time clock with radio-controlled function

PACKAGE CONTENTS

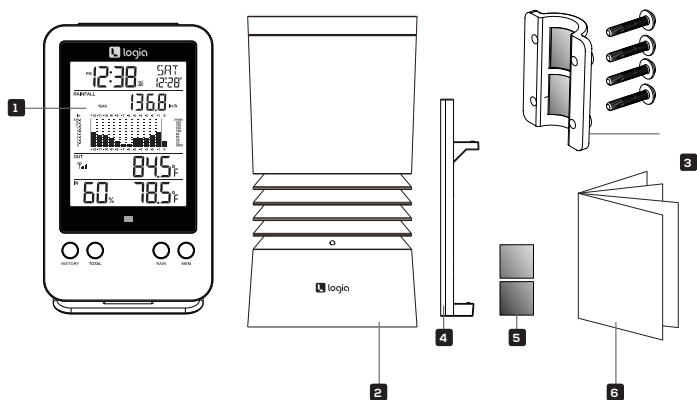

1. Weather display console with detachable kickstand
2. 3-in-1 rain sensor
3. Mounting clamp with four (4) screws and hex nuts
4. Mounting base
5. Rubber pads
6. User guide

PRODUCT OVERVIEW

WEATHER CONSOLE OVERVIEW

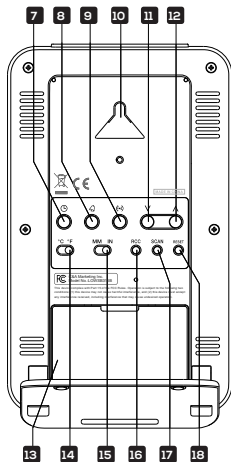
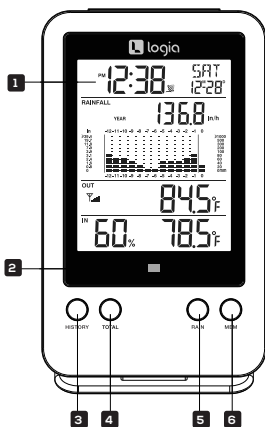
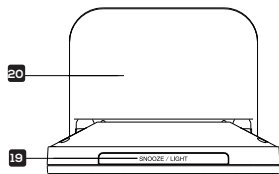

- | | | |
|--------------------|--------------------------|-------------------------|
| 1. LCD display | 9. ALERT button | 17. SCAN button |
| 2. Alert indicator | 10. Wall mounting holder | 18. RESET button |
| 3. HISTORY button | 11. DOWN button | 19. SNOOZE/LIGHT button |
| 4. TOTAL button | 12. UP button | 20. Kickstand |
| 5. RAIN button | 13. Battery compartment | |
| 6. MEM button | 14. °C/°F slider | |
| 7. CLOCK button | 15. MM/IN slider | |
| 8. ALARM button | 16. RCC button | |

RAIN SENSOR OVERVIEW

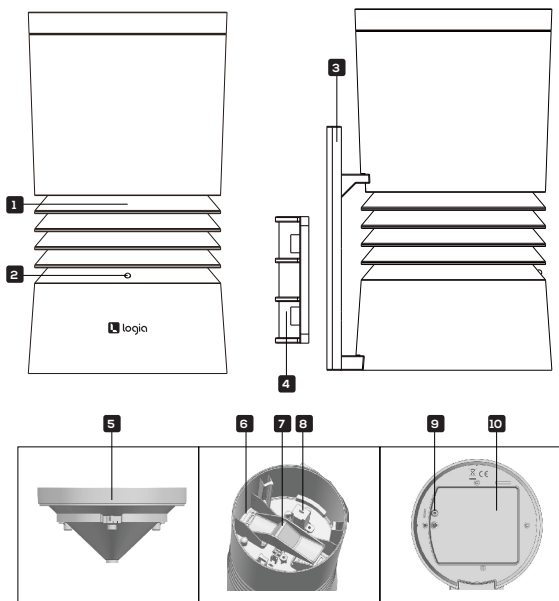

1. Radiation shield
2. Red LED indicator
3. Mounting base
4. Mounting clamp
5. Rain collector

6. Drain holes
7. Tipping bucket
8. Rain sensor
9. RESET button
10. Battery compartment

LCD DISPLAY OVERVIEW

Time/Calendar Display

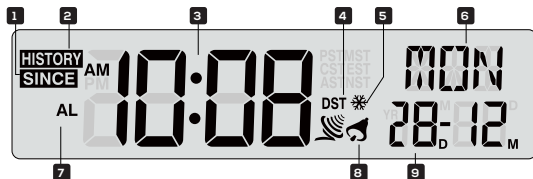

1. SINCE icon
2. HISTORY icon
3. Time
4. DST icon
5. Ice-alert icon
6. Day of the week
7. Alarm mode
8. Alarm icon
9. Calendar

Rainfall Display

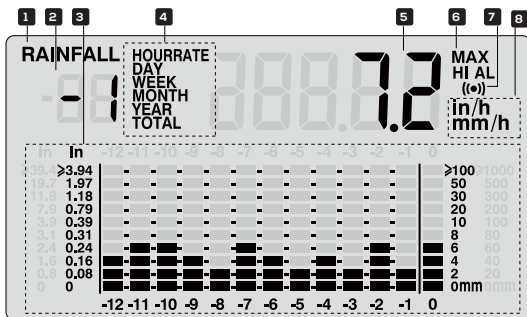

1. Rainfall indicator
2. Past time
3. Histogram
4. Time range record indicator
5. Rainfall reading
6. MAX indicator
7. HI alert and alarm
8. Rainfall unit

Outdoor Temperature Display

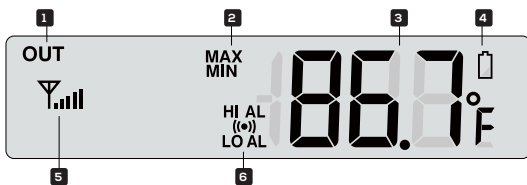

1. Outdoor indicator
2. MAX/MIN indicator
3. Outdoor temperature
4. Low battery indicator for sensor
5. Outdoor signal strength indicator
6. HI/LO alert and alarm

Indoor Temperature/Humidity Display

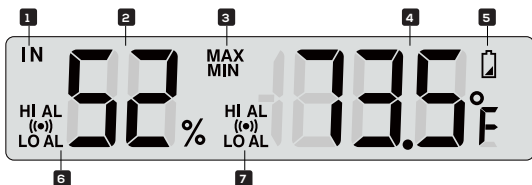

1. Indoor indicator
2. Indoor humidity
3. MAX/MIN indicator
4. Indoor temperature
5. Low battery indicator for console
6. HI/LO alert and alarm for humidity
7. HI/LO alert and alarm for temperature

■ INSTALLATION INSTRUCTIONS

SETTING UP THE 3-IN-1 RAIN SENSOR

The 3-in-1 rain sensor measures rainfall and temperature for you.

Installing the Batteries

1. Unscrew the battery door at the bottom of the rain sensor using a screwdriver (not included).
2. Insert four (4) AA batteries (not included) according to the +/- polarity labeled in the compartment.
3. Screw the battery door back onto the compartment.

NOTES: The LED light will flash red every 12 seconds.

Press the RESET button after each battery change.

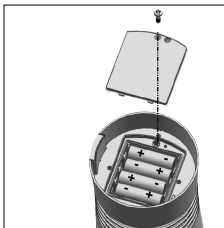

Mounting the Rain Sensor

1. Pick a location for the 3-in-1 rain sensor that's open with no obstructions.
2. Place the mounting base of the rain sensor against the side of a pole. Then, add rubber pads into the interior of the mounting clamp before fastening the mounting clamp on the mounting base with the four (4) screws and nuts.
3. Slide the rain sensor onto the mounting base. Ensure the sensor is level to achieve accurate rain measurements.

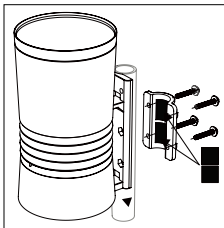

NOTES: When placing the rain sensor, make sure it is within 328' (100 m) of the display console.

Place the mounting base and clamp on a steel pole or post that is a minimum of 4.9' (1.5 m) off the ground.

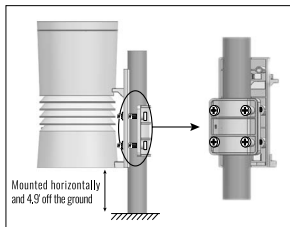

SETTING UP THE DISPLAY CONSOLE

The console can be set up on a table or mounted up on a wall.

Installing the Batteries

1. Remove the battery door on back of the console.
2. Insert two (2) AA batteries (not included) into the compartment.
3. Place the battery door back onto the compartment.
4. Press the SCAN button on the console if the wireless signal “Y” is not flashing, to manually activate the linking process.



NOTES: If nothing appears on the display after inserting the battery, then press the RESET button using a pin.

After successfully linking with the sensor, the clock will automatically set its time indicated by the radio-controlled (RC) signal “☀”.

Pairing the Console with the 3-in-1 Rain Sensor

1. After inserting the batteries, the display console will automatically search and connect to the wireless sensor.
2. Once the connection is successful, the wireless signal and readings for outdoor temperature and rainfall will appear on the display.

Changing Batteries and Manual Pairing of Sensor

Whenever you change the batteries of the rain sensor, pairing must be done manually.

1. Change all the batteries to new ones.
2. Press the RESET button on the sensor to acquire a new code for pairing.
3. Press the SCAN button on the console to enter pairing mode.

Installing the Kickstand



Connect the kickstand to the bottom of the display console before placing the console on a flat surface.

■ OPERATING INSTRUCTIONS

TIME & CALENDAR

Manually Setting the Time

The display console is designed to synchronize itself using the RCC signal, however you can set the time manually if needed. During initial setup, you will need to press and hold the RCC button for eight (8) seconds to deactivate RCC reception. Press and hold the RCC button again for eight (8) seconds to turn the signal back on.

 RCC on	 RCC off
--	--

1. To manually set clock, press and hold the CLOCK button for two (2) seconds and the "12/24 Hr" symbol will begin to flash.
2. Press the UP or DOWN button to adjust the time settings.
3. Press the CLOCK button again to proceed to the next setting.
4. Settings will cycle through the following options: Time Zone > Hour > Minute > Year > Month & Date/Date & Month > Date > Hour offset > Language > DST AUTO/OFF.
5. Press the CLOCK button one final time after adjusting all settings options to save and exit, or the console will automatically save and exit the menu after 60 seconds of no button presses.

NOTES: DST (daylight saving time) feature is only valid when the RCC function is on.

The DST feature is set to AUTO by default.

You can select between PST, MST, CST, EST, AST, or NST for your time zone.

The language options are English (EN), French (FR), German (DE), Spanish (ES), Italian (IT), Dutch (NL), and Russian (RU).

Setting the Alarm Time

If you'd like to use your display console as an alarm clock, follow these instructions to set the alarm time:

1. In normal operating mode, press and hold the ALARM button for two (2) seconds until the alarm hour starts flashing. This indicates that you have entered the alarm time setting mode.
2. Use the UP or DOWN button to adjust the alarm hour. Press and hold either button to move through the hours quickly.
3. Press the ALARM button again to confirm the alarm hour and move to adjusting the minutes. The minute digits should be flashing.
4. Use the UP or DOWN button to adjust the alarm minute. Press and hold either button to move through the minutes quickly.

5. Press the ALARM button to save and exit the menu.

NOTE: The alarm icon will display on screen once the alarm time is set.

Activating/Deactivating the Alarm & Temperature Pre-Alarm

The temperature pre-alarm (alarm with ice-alert) will alert you 30 minutes prior to your alarm time whenever the outdoor temperature falls below 26.5 °F (-3 °C).







1. In normal operating mode, press the ALARM button to display the set alarm time.
2. When the alarm time is being shown on the LCD display, press the ALARM button again to cycle through the alarm functions (Alarm off/Alarm on/Temperature Pre-alarm) as shown below. The corresponding icons will appear on the LCD display.

		
Alarm off	Alarm on	Alarm with ice-alert

RAIN

Select the Rainfall Display Mode

The device displays how many millimeters (mm) or inches (in.) of rain are accumulated in an hour, based on current rainfall rate. Press the RAIN button to toggle between:

RATE		Current rainfall rate in the past hour
HOURLY		Total rainfall in the past hour
DAILY		Total rainfall since midnight
WEEKLY		Total rainfall for the current week
MONTHLY		Total rainfall since the beginning of the current month
TOTAL		Total rainfall since the last reset

Set the Rainfall Units

Use the MM/IN slider to select the measurement unit between mm or in.

Graphical Histogram Display

Histogram presents an easy view of rainfall change pattern over a period of time in a graphical manner. The time scale of the graph automatically changes according to the rainfall display modes: Rate > Hour > Day > Week > Month > Year



NOTES: By default, the graph is presented in the hourly scale when viewing the rate of rainfall.

There is no graphical display when yearly rainfall is detected.

Using the TOTAL (Total Rainfall) function

- Press the TOTAL button to display the total rainfall record.
- To clear the previous data, press and hold the TOTAL button.

HISTORY

Checking the History Data

Press the HISTORY button to view each period of time scale.

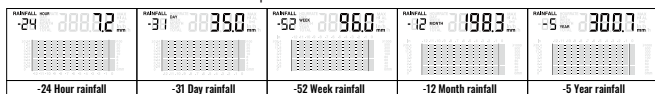

TEMPERATURE & HUMIDITY DISPLAY

The weather console displays outdoor temperature received from the Rain sensor, as well as indoor temperature and humidity from the built-in sensors.

- Press the °C/°F button to select the temperature unit between Celsius or Fahrenheit.

MAX/MIN MEMORY

Press the MEM button to check MAX/MIN records.

AREA	Outdoor Temperature		Indoor Temperature		Indoor Humidity		Hour/Day/Week/ Month/Year rainfall
TYPE OF MEMORY	Max.	Min.	Max.	Min.	Max.	Min.	Max.

Clearing the MAX/MIN Records

While the maximum or minimum readings are displayed, press and hold the MEM button for two (2) seconds to clear individual records.

HI/LO ALERT

HI/LO alert is used to warn users of certain weather conditions. Once activated, the alarm will turn on and the red LED will start to flash when a certain pre-set criteria is met.

AREA	TYPE OF ALERT AVAILABLE
Indoor temperature	HI and LO alert
Indoor humidity	HI and LO alert
Outdoor temperature	HI and LO alert
Hour rainfall	HI alert
Day rainfall	HI alert

Setting the HI/LO Alert

1. Press the ALERT button until the desired area is selected.
2. Use the UP or DOWN button to adjust the setting.
3. Press the ALERT button to confirm and continue to next setting.

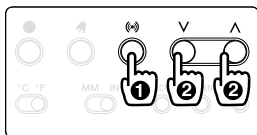

Activating/Deactivating the HI/LO Alert

1. Press the ALERT button until the desired area is selected.
2. Press the ALARM button to turn the alert on or off.
3. Press the ALERT button to continue to next setting.

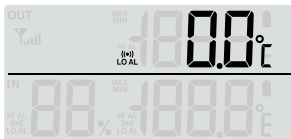

Silence the HI/LO Alert Alarm

Press the SNOOZE/LIGHT button to silence the alarm, or it will automatically turn off after two (2) minutes.

NOTES: Once the alert is triggered, the alarm will sound for two (2) minutes and the associated alert icon and will flash.

The SNOOZE/LIGHT button can also be used to dim the backlight of the display.

WIRELESS SIGNAL RECEPTION

The rain sensor is capable of transmitting data wirelessly over an approximate operating range of 492' (150 m) (with line of sight). Occasionally, due to intermittent physical obstructions or other environmental interference, the signal may be weakened or lost. In the case of the sensor signal getting lost completely, you will need to relocate the console or the weather sensor.

No sensor	Signal searching	Strong signal	Weak signal	Signal lost

DATA CLEARING

To clear all data:

1. Press and hold the HISTORY button for three (3) seconds.
2. Press the UP or DOWN button to choose "YES" or "NO".
3. Press the HISTORY button to confirm. This will clear out any rainfall data recorded before.

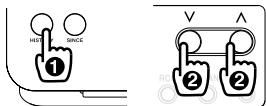



■ CARE/MAINTENANCE

CLEANING THE RAIN COLLECTOR

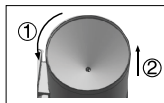
1. Unscrew the rain collector by turning the rain collector counterclockwise.
2. Gently remove the rain collector.
3. Clean and remove any debris or insects from the rain collector.
4. Install the rain collector when it is clean and fully dried.



■ TROUBLESHOOTING

Problem	Solution
No data or measurement coming in from rain sensor.	<ul style="list-style-type: none">• Check the drain hole in the rain collector.• Check the balance indicator.
No data or measurement coming in from hygro-thermo sensor.	<ul style="list-style-type: none">• Check the radiation shield.• Check the sensor casing.
If one of these symbols  or  appear, the signal on your console has been lost.	<ul style="list-style-type: none">• Relocate the console and outdoor sensor making sure the two are close together.• Make sure the console is away from other electronic appliances (ex. TVs, computers, microwaves) in your home.• Reset the console and outdoor sensor if problem continues.
Temperature reading is too high in the daytime.	Make sure the sensor is not too close to any heat-generating sources.

SPECIFICATIONS

DISPLAY CONSOLE	
GENERAL SPECIFICATIONS	
Product type:	Weather/environment sensor & console
Dimensions (W x H x D):	3.7" x 6.1" x 0.9" (95 x 155 x 23 mm)
Weight:	0.5 lbs. (212 g) (without batteries)
Power source:	2 x AA 1.5 V batteries
Adult assembly required for console:	No
Location use for console:	Indoor use
Additional tools required for console:	No
Country of origin:	China
Warranty included:	Yes
Warranty length:	1 year
RADIO-CONTROLLED/ATOMIC CLOCK SPECIFICATIONS	
Synchronization:	Auto or disabled
Clock display:	HH: MM/weekday
Hour format:	12hr (AM/PM) or 24hr
Calendar:	DD/MM/YR or MM/DD/YR
Weekday in 7 languages:	EN/FR/DE/ES/IT/NL/RU
RCC time signal:	WWVB
Time zone:	PST, MST, CST, EST, AST, NST
DST:	Auto/off
INDOOR TEMPERATURE DISPLAY & FUNCTION SPECIFICATIONS	
Temperature unit:	°C or °F
Display range:	-40 °F - 158 °F (-40 °C - 70 °C) (< -40 °F: LO; > 158 °F: HI)
Operating range:	14 °F - 122 °F (-10 °C - 50 °C)
Accuracy:	+/- 2 °F or 1 °C @ 77 °F (25 °C)
Resolution:	0.1 °F/0.1 °C
Display modes:	Current, MAX/MIN, historical data for past 24 hours
Memory modes:	MAX & MIN from last memory reset
Alarm:	HI/LO temperature alert
INDOOR HUMIDITY DISPLAY & FUNCTION SPECIFICATIONS	
Display range:	20% - 90% RH (< 20%: LO; > 90%: HI)
Operating range:	20% - 90% RH
Accuracy:	20% - 39% RH ± 8% RH @ 77 °F (25 °C) 40% - 70% RH ± 5% RH @ 77 °F (25 °C) 71% - 90% RH ± 8% RH @ 77 °F (25 °C)

Resolution:	1%
Display modes:	Current, MAX/MIN, historical data for past 24 hours
Memory modes:	MAX & MIN from last memory reset
Alarm	HI/LO temperature alert
WIRELESS 3-IN-1 OUTDOOR RAIN SENSOR	
GENERAL SPECIFICATIONS	
Dimensions (W x H x D):	4.3" x 7.9" x 4.3" (109 x 200 x 109 mm)
Weight:	0.8 lbs. (372 g) (without batteries)
Main power:	4 x AA 1.5 V batteries (lithium batteries recommended)
Weather data:	Temperature and rainfall
RF transmission range:	Up to 492' (150 m)
RF frequency:	915 MHz
Transmission interval:	Every 12 seconds
Location use for sensor:	Outdoor use
Adult assembly required for sensor:	Yes
Additional tools required for sensor:	Screwdriver
OUTDOOR TEMPERATURE DISPLAY & FUNCTION SPECIFICATIONS	
Temperature unit:	°C or °F
Display range:	-40 °F - 176 °F (-40 °C - 80 °C) (< -40 °F: LO; > 176 °F: HI)
Operating range:	-40 °F - 140 °F (-40 °C - 60 °C)
Resolution:	0.1 °F/0.1 °C
Accuracy:	+/- 1 °F or 0.5 °C @ 77 °F (25 °C)
Display modes:	Current, MAX/MIN, historical data for past 24 hours
Memory modes:	MAX & MIN from last memory reset
Alarm	HI/LO temperature alert
RAIN DISPLAY & FUNCTION SPECIFICATIONS	
Rainfall unit:	mm and in
Accuracy for rainfall:	< 0.01" (0.2 mm); ± 7%; 5" (127 mm); +/- 7%
Range for rainfall:	0 - 1,181.1" (0 - 29999 mm)
Resolution:	0.01" (254 mm)
Display modes:	Rainfall in hourly rate, hourly, daily, weekly, monthly, and yearly
Memory modes:	Maximum rain
Alarm:	Hourly or daily high rainfall alert
HI display:	Hour rainfall > 39.4" (999.9 mm); Day rainfall > 393.7" (9999 mm); Week/month/total rainfall > 1181.1" (29999 mm)

LIMITED WARRANTY TO ORIGINAL CONSUMER

This Logia 3-in-1 Rain Sensor and LCD Display with Built-In Hygro-Thermo Sensor ("Product"), including any accessories included in the original packaging, as supplied and distributed new by an authorized retailer is warranted by C&A Marketing, Inc. (the "Company") to the original consumer purchaser only, against certain defects in material and workmanship ("Warranty") as follows:

To receive Warranty service, the original consumer purchaser must contact the Company or its authorized service provider for problem determination and service procedures. Proof of purchase in the form of a bill of sale or receipted invoice, evidencing that the Product is within the applicable Warranty period(s), MUST be presented to the Company or its authorized service provider in order to obtain the requested service.

Service options, parts availability, and response times may vary and may change at any time. In accordance with applicable law, the Company may require that you furnish additional documents and/or comply with registration requirements before receiving warranty service. Please contact our customer service for details on obtaining warranty service:

Email: info@supportcbp.com

Phone: 833-815-0568

Shipping expenses to the Company's Return Facility are not covered by this warranty, and must be paid by the consumer. The consumer likewise bears all risk of loss or further damage to the Product until delivery to said facility.

EXCLUSIONS AND LIMITATIONS

The Company warrants the Product against defects in materials and workmanship under normal use for a period of ONE (1) YEAR from the date of retail purchase by the original end-user purchaser ("Warranty Period"). If a hardware defect arises and a valid claim is received within the Warranty Period, the Company, at its sole option and to the extent permitted by law, will either (1) repair the Product defect at no charge, using new or refurbished replacement parts, (2) exchange the Product with a Product that is new or which has been manufactured from new or serviceable used parts and is at least functionally equivalent to the original device, or (3) refund the purchase price of the Product.

A replacement Product or part thereof shall enjoy the warranty of the original Product for the remainder of the Warranty Period, or ninety (90) days from the date of replacement or repair, whichever provides you longer protection. When a Product or part is exchanged, any replacement item becomes your property, while the replaced item becomes the Company's property. Refunds can only be given if the original Product is returned.

This Warranty does not apply to:

- (a) Any non-Logia 3-in-1 Rain Sensor and LCD Display with Built-In Hygro-Thermo Sensor product, hardware or software, even if packaged or sold with the Product;
- (b) Damage caused by use with non-Logia 3-in-1 Rain Sensor and LCD Display with Built-In Hygro-Thermo Sensor products;
- (c) Damage caused by accident, abuse, misuse, flood, fire, earthquake, or other external causes;
- (d) Damage caused by operating the Product outside the permitted or intended uses described by the Company;
- (e) Damage caused by third party services;
- (f) A Product or part that has been modified to alter functionality or capability without the written permission of the Company;
- (g) Consumable parts, such as batteries, fuses, and bulbs;
- (h) Cosmetic damage; or
- (i) If any Logia 3-in-1 Rain Sensor and LCD Display with Built-In Hygro-Thermo Sensor serial number has been removed or defaced.

This Warranty is valid only in the country where the consumer purchased the Product, and only applies to Products purchased and serviced in that country.

The Company does not warrant that the operation of the Product will be uninterrupted or error-free. The Company is not responsible for damage arising from your failure to follow instructions relating to its use.

NOTWITHSTANDING ANYTHING TO THE CONTRARY AND TO THE MAXIMUM EXTENT PERMITTED BY APPLICABLE LAW, THE COMPANY PROVIDES THE PRODUCT "AS-IS" AND "AS-AVAILABLE" FOR YOUR CONVENIENCE AND THE COMPANY

AND ITS LICENSORS AND SUPPLIERS EXPRESSLY DISCLAIM ALL WARRANTIES AND CONDITIONS, WHETHER EXPRESSED, IMPLIED, OR STATUTORY, INCLUDING THE WARRANTIES OF MERCHANTABILITY, FITNESS FOR A PARTICULAR PURPOSE, TITLE, QUIET ENJOYMENT, ACCURACY, AND NON-INFRINGEMENT OF THIRD-PARTY RIGHTS. THE COMPANY DOES NOT GUARANTEE ANY SPECIFIC RESULTS FROM THE USE OF THE PRODUCT, OR THAT THE COMPANY WILL CONTINUE TO OFFER OR MAKE AVAILABLE THE PRODUCT FOR ANY PARTICULAR LENGTH OF TIME. THE COMPANY FURTHER DISCLAIMS ALL WARRANTIES AFTER THE EXPRESS WARRANTY PERIOD STATED ABOVE.

YOU USE THE PRODUCT AT YOUR OWN DISCRETION AND RISK. YOU WILL BE SOLELY RESPONSIBLE FOR (AND THE COMPANY DISCLAIMS) ANY AND ALL LOSS, LIABILITY, OR DAMAGES RESULTING FROM YOUR USE OF THE PRODUCT.

NO ADVICE OR INFORMATION, WHETHER ORAL OR WRITTEN, OBTAINED BY YOU FROM THE COMPANY OR THROUGH ITS AUTHORIZED SERVICE PROVIDERS SHALL CREATE ANY WARRANTY.

IN NO EVENT WILL THE COMPANY'S TOTAL CUMULATIVE LIABILITY ARISING FROM OR RELATED TO THE PRODUCT, WHETHER IN CONTRACT OR TORT OR OTHERWISE EXCEED THE FEES ACTUALLY PAID BY YOU TO THE COMPANY OR ANY OF ITS AUTHORIZED RESELLERS FOR THE PRODUCT AT ISSUE IN THE LAST YEAR FROM YOUR PURCHASE. THIS LIMITATION IS CUMULATIVE AND WILL NOT BE INCREASED BY THE EXISTENCE OF MORE THAN ONE INCIDENT OR CLAIM. THE COMPANY DISCLAIMS ALL LIABILITY OF ANY KIND OF ITS LICENSORS AND SUPPLIERS. IN NO EVENT WILL THE COMPANY OR ITS LICENSORS, MANUFACTURERS, AND SUPPLIERS BE LIABLE FOR ANY INCIDENTAL, DIRECT, INDIRECT, SPECIAL, PUNITIVE, OR CONSEQUENTIAL DAMAGES (SUCH AS, BUT NOT LIMITED TO, DAMAGES FOR LOSS OF PROFITS, BUSINESS, SAVINGS, DATA, OR RECORDS) CAUSED BY THE USE, MISUSE, OR INABILITY TO USE THE PRODUCT.

Nothing in these terms shall attempt to exclude liability that cannot be excluded under applicable law. Some countries, states, or provinces do not allow the exclusion or limitation of incidental or consequential damages or allow limitations on warranties, so certain limitations or exclusions may not apply to you. This warranty gives you specific legal rights, and you may have other rights that vary from state to state or province to province. Contact your authorized retailer to determine if another warranty applies.

FCC STATEMENT

This device complies with Part 15 of the FCC Rules. Operation is subject to the following two conditions:

(1) This device may not cause harmful interference, and:

(2) This device must accept any interference received, including interference that may cause undesired operation.

NOTE: This equipment has been tested and found to comply with the limits for a Class B digital device, pursuant to part 15 of the FCC Rules. These limits are designed to provide reasonable protection against harmful interference in a residential installation. This equipment generates—and can radiate—radio frequency energy and, if not installed and used in accordance with the instructions, may cause harmful interference to radio communications.

However, there is no guarantee that interference will not occur in a particular installation. If the equipment does not cause harmful interference to radio or television reception, which can be determined by turning the equipment off and on, the user is encouraged to try to correct the interference by one or more of the following measures:

- Reorient or relocate the receiving antenna
- Increase the separation between the equipment and the receiver
- Connect the equipment into an outlet on a circuit different from that to which the receiver is connected.
- Consult the dealer or an experienced radio/TV technician for help.

The provided shielded USB cable must be used with this unit to ensure compliance with the class B FCC limits.

Warning: Changes or modifications to this unit not expressly approved by the party responsible for compliance could void the user's authority to operate the equipment.

LOGIA is a trademark of C&A IP Holdings LLC in the US, Canada, China, and the EU.

All other products, brand names, company names, and logos are trademarks of their respective owners, used merely to identify their respective products, and are not meant to connote any sponsorship, endorsement, or approval.

Distributed by C&A Marketing, Inc., 114 Tived Lane East, Edison, NJ 08837. Made in China.

© 2021. C&A IP Holdings LLC. All Rights Reserved.

If you experience any issues with your Logia 3-in-1 Rain Sensor and LCD Display with Built-In Hygro-Thermo Sensor, please contact us before returning your product to the place of purchase. We're here to help!

QUESTIONS OR PROBLEMS? CONTACT US!

Email: info@supportcbp.com or call: 1-833-815-0568

www.logiaweatherstation.com